

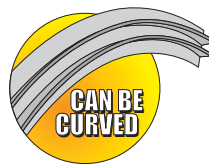

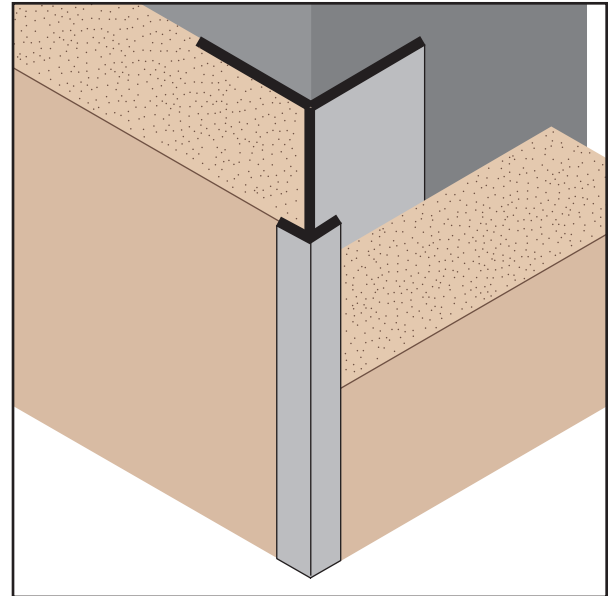







PCM: Plaster Corner Molding

Creates a plaster stop and high strength corner for conventional 3-coat stucco with an aesthetically pleasing exposed edge at all outside corner conditions.



KEY	
	PLASTER/STUCCO
	CONCRETE
	PLYWOOD
	WOOD
	FOAM
	WATERPROOF BARRIER
	WALL SHEATHING
	DRYWALL
	DRYWALL MUD
	FIBER CEMENT

Length	X Size	Y Size
10'	3/4"	7/8"
		1 5/8"

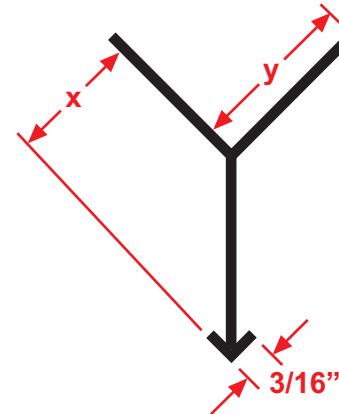

Materials:

- Aluminum Alloy (6063 T-5)

Note: Standard length is 10 feet.
 Additional lengths available upon request.

ASTM Codes:

- B136 (Anodize Coating)
- B244 (Anodize Coating)
- C1063 (Accessories)
- D4214 (Paint Films)
- B221-14 (Aluminum)

