



Stockton

PRODUCTS™

**METAL
PRODUCTS**

We offer an extensive variety
of standard and custom
metal products for ventilation,
moisture management and
decorative reveal purposes.

StocktonProducts.com
877-862-5866



Founded in 1949 in response to construction demand in the Southwestern United States, Stockton Products™ pioneered a wire framework around which stucco could be applied to keep it from cracking at stress points. Stockton Products™ developed a welded wire corner to meet this need and named it CornerAid®. It quickly became, and remains, the industry standard. Over the following 74 years, Stockton Products™ would introduce many unique “wire-corner” products including Stainless Steel varieties, Plastic Nose Cornerbead with a non-rust high impact PVC nose; ArchAid® for rounded door frames and openings and PopOutAid™ used to form decorative pop outs around windows and doors as well as other ornamental trim details.

As the business grew and prospered, Stockton Products™ expanded into metal vents, reveals, and trims. Today the company manufactures a full line of these products in aluminum, galvanized steel, galvalume®, bonderized steel, copper, stainless steel and zinc. The company expanded its metal fabrication capabilities with the addition of a fiber laser, new press brakes, two small parts brakes and a turret punch to provide a wider variety of custom products in heavier gauges with the opening of an additional fabrication sites in Southern California and Phoenix. This expanded capability provides our customers with unparalleled part quality and reproducibility that is best in class.

Stockton Products™ serves the US and Canada from six manufacturing and warehouse locations in the Western US. The company has stocking distributors throughout North America. All of Stockton’s products are proudly made in the US. Its product quality, consistency, and breadth of offering are widely acknowledged to be the best in the industry. The company looks forward to serving your needs today and for another 70 plus years.

President
Stockton Products™

Headquarters: 4675 Vandenberg Drive, North Las Vegas, NV 89081
1-87-STOCKTON – (877) 862-5866 • (702) 651-1721 • Fax (702) 651-1303

Manufacturing & Distribution Centers:
North Las Vegas, NV • Burbank, CA • Livermore, CA • Orange, CA • Phoenix, AZ

www.StocktonProducts.com

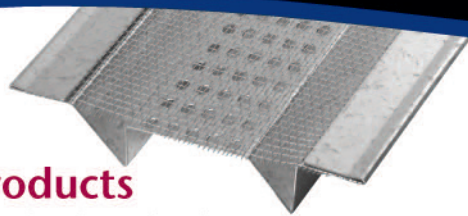

Metal Products

Featuring: EmberStop®, BugStop®, M-Slide Expansion Joint®, SolidGround®, Tru-Corner®, Superior Moisture Protection™, Tru-Weep™ and Vent-Rite™

We offer an extensive variety of standard and custom metal products for ventilation, moisture management and decorative reveal purposes.

Contractors

We proudly serve the lathing, plastering, panel system and fireproofing industries with a wide variety of vent & reveal screeds, metal trims and aluminum extrusions. We also offer the most complete line of pre-shaped welded wire accessories to be used on corners, arches, doorways, windows, walls and foundations. Our products insure ease of application and proper plaster thickness. We use the finest metals and wire in all of our products which offer maximum strength, easy tailoring and rust resistance.

Call customer service at **1-87-STOCKTON** (1-877-862-5866) for the name of your nearest Stockton Products™ dealer or visit our Distributor Finder on our website.

Building Material Dealers

We diligently guard our solid reputation for excellent design, excellent quality and excellent service. We are committed to having your every contact with our staff be a positive and professional experience. We carry a large inventory of most items in each of our distribution centers and offer a special order service for unusual and non-standard items. Stockton Products™ is always receptive to your new product ideas and needs. Call us at **1-87-STOCKTON**.

Architects

For 60+ years, we have offered architects a full line of lathing and plastering accessories to meet the challenges of creative architectural design. Our welded truss design, of the finest galvanized wire, builds into the structure a superior strength and is easily aligned and applied over stucco netting. The end result assures...

- Corners sculptured to your design
- A solid reinforced corner, with mechanical bond
- Straight line on the arris, canopies, balconies and corners

Our complementary line of metal trims and aluminum extrusion products also enjoy great popularity and acceptance because they meet the practical design requirements necessary both from an aesthetic and functional perspective.

For confidence in structural integrity and an adherence to your creative design requirements, specify Stockton Products™.

Introduction	3
Stockton Custom Fabrication	4-5
New Metal Products	5
Metal - Overview	7
Ordering, Radius Shapes	8
Materials and Finish Guide	9
Proper Measurement	10
Ventilation, Hole Reference	11
Index of Metal Products	11-18
Metal Products	19-49
Support Products	50
Part Number Reference Information	51

Disclaimer

Product illustrations are for reference only. Illustrations are not to a set scale and may not accurately represent every possible configuration, nor number of vent holes/weep holes/key holes or placement of said "holes". For precise information on any product, please call customer service at **1-87-STOCKTON** (1-877-862-5866)

Warranty

Stockton Products™ Corporation warrants that its products are in compliance with their published specifications and are free from defects in materials and workmanship for a period of two (2) years from the date of purchase.

This warranty does not apply to loss due to misuse, abuse or incorrect and/or improper installation and/or application.

Material deemed to be defective will be replaced at no charge by Stockton Products™, but in no event or instance shall Stockton Products™ be liable for any other costs or damages, including any labor cost.

This express warranty is given in lieu of and excludes all other express or implied warranties. Including but not limited to the implied warranties of merchantability and fitness for the particular purpose.

Stockton Products™ sole obligations under this warranty are set forth herein. In no event shall Stockton Products™ be liable for any lost revenue or profits, direct and indirect special, incidental or consequential damages of any kind.

About Our Cover...

This cover features a selection of the different metal material Stockton Products offers.



Stockton Custom Fabrication

Stockton Products™ Has Made Some Exciting Changes In Our Livermore, Orange and Phoenix Facilities.

In order to expand our metal forming capabilities, we have made a significant investment in state-of-the-art equipment and experienced personnel to accomplish this goal.

Established as "Stockton Custom Fabrication", this new division will permit us to greatly expand our product line and market reach and give us the ability to offer all types of custom fabricated metal items as well as expand our current line of stock metal items through innovation and cost saving economies.

Automated Sheet Metal Fabrication

Stockton Products can support any sheet metal projects with our state of the art metal fabrication facilities. Stockton Products™ has invested in the latest tech to support growing demands and evolving business. Our capabilities include 2D fiber laser cutting, high speed punching and precision metal forming equipment. Our equipment is equipped with automated loading and unloading, CNC 6 axis back gauges and CNC controlled laser and turret punching technology. Stockton Products is set up for prototyping, medium to large scale production operations to satisfy all customer expectations.

Software

Our software allows for our design team to create your design and bring it to reality through 3D modeling and programming.

Roll Forming

Our highly skilled roll forming department has a lot to offer our customers. Our ability to produce product at a high rate and maintain precise tolerances has always been a goal of Stockton Products™. We roll form thousands of parts and stock our five locations (North Las Vegas, NV • Burbank, CA • Livermore, CA • Orange, CA • Phoenix, AZ) to satisfy our customers' expectations and reduce lead times.

TruLaser 3040

TruLaser 3040 fiber cuts extremely quick with high edge quality this solid-state laser enables the processing of non-ferrous metals and provides productivity benefit in thick and thin sheets. The 80" x 160" bed allows for processing of large parts. This machine is also equipped with automation for lights out operations.

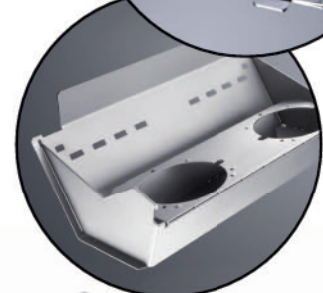
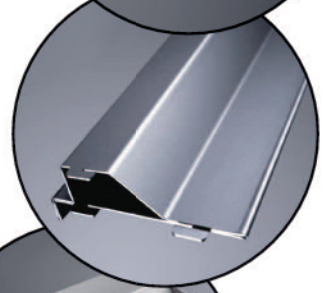
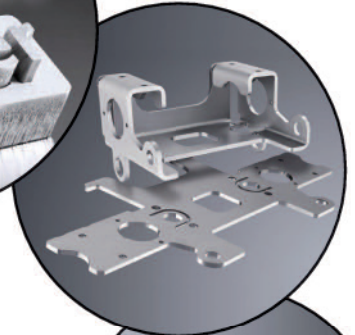

Equipment List

- Trumpf TruArc Weld 1000
- Trumpf TruLaser 3040 Fiber Laser
- Trumpf TruMatic Punch 2020
- Trumpf TruBend 5170
- Trumpf TruBend 7036
- Trumpf TruTops Boost Software
- Komatsu 20 Ton Punch Press
- Dahlstrom Rollformer
- Yoder Rollformer
- Cidan Fx30 Folder
- Ras Turbobend Folder
- Ras Shear
- Haco .25 X 12 Shear
- Lincoln Power Mig Welder
- Tommy Industrial 55 Ton



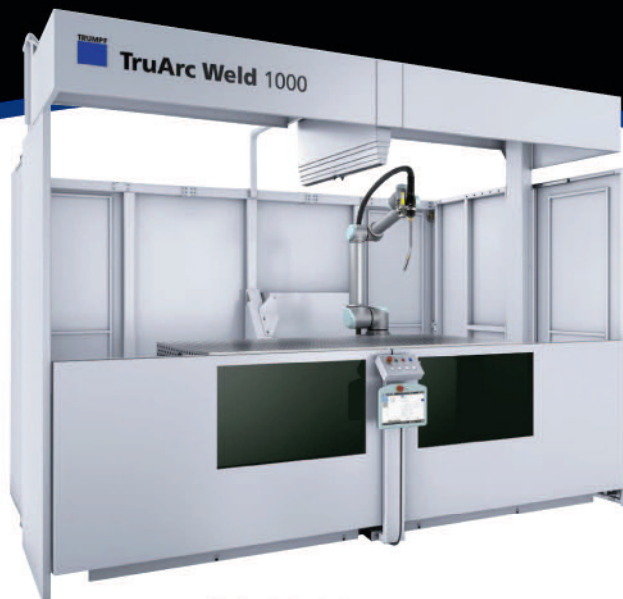

TruArc Weld 1000

Have a custom welding project or just need some wall posts? Stockton Products™ now offers CE Certified robotic welding. Delivering top-quality welds on steel, stainless and aluminum with a high-quality appearance and highly durable seams.



TruBend 5170

14ft 170 ton TruBend 5170 press brake is capable of bending thin & thick complex sheet metal parts with high levels of angular accuracy. Features such as lower tool displacement for hemming and 6 axis backgauge provide us a unique advantage and complete production freedom from programming, to set up, to bending productivity the innovated features of this machine allow us to be unmatched in quality and productivity.



TruMatic 2020 Punch

The TruMatic 2020 Punching machines from TRUMPF enable you to process a diverse range of parts with flexibility.

In addition to punching, the machines provide the option to form sheet metal parts or to integrate a thread – all on one machine. The punching head can turn the tool to any angular position. This minimizes setup times and increases your productivity. Innovative developments such as the active and descending die guarantee the best part quality. Intelligent automation options relieve the operator and increase throughput.

Numerous Application Possibilities With The Highest Productivity

With the MultiTool tools, you can not only carry out punching processes highly productively, but you can also form and emboss. Up to ten different inserts in one tool adapter ensure shorter setup and tool change times. Particularly when it comes to processing sheet parts with varying small punching operations and large slot sizes.



TruBend 7036

The TruBend 7036 is exceptional for prototyping and processing of small intricate parts with tight bends and tolerances. This high speed agronomical pressbrake has 36tons of press force with a 6 axis backgauge Small, precise bends with short flanges make this machine a perfect tool for large or small production runs.



New Metal Products

This page is dedicated to the new innovative products being offered from Stockton Products™.

To see our latest products visit:
www.StocktonProducts.com/NEW

Page 19

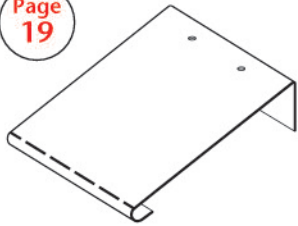

BFC: Breakaway Form Clip

Page 20

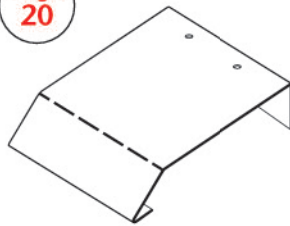

BFCA: Breakaway Form Clip - Angles

Page 20



BJB: Bullnose J Bead

Page 21



CICJ: #9 Control Joint

Page 24

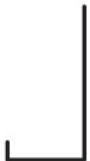

DWS: DripWave® Weep Screed

Page 29



HCV: Vented Hat Channel

Page 31

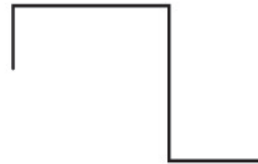

JLC: JL Corner (Shaft Wall)

Page 31



MFR: Finish Rite® M-Slide Expansion Joint® (2 Piece)

Page 32



MSXE: Econo M-Slide Expansion Joint® (2 Piece)

Page 42



TVSS: Top Vent Stucco Screed

Page 42



TWBF: Tru-Weep™ Base Flashing

Page 42



TWCB: Tru-Weep™ Casing Bead

NEW

Stockton

PRODUCTS™

Page 42



TWHJ: Tru-Weep™ #9 Horizontal Control Joint

Page 43

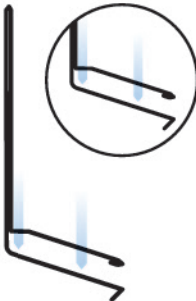

TWHJ-CI: Tru-Weep™ #9 Horizontal Control Joint

Page 43

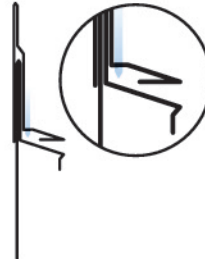

TWMFR: Tru-Weep™ Finish Rite® M-Slide Expansion Joint®

Page 43

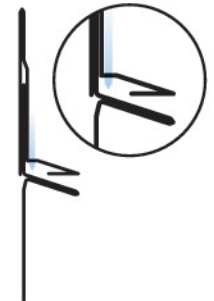

TWMSC: Tru-Weep™ M-Slide Expansion Joint®

Page 44

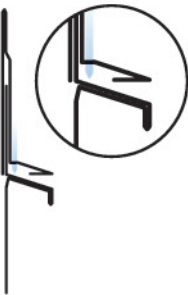

TWMSX: Tru-Weep™ M-Slide Expansion Joint®

Page 44



TMMW: Tru-Weep™ Midwall Vent

Page 44



TWSD: Tru-Weep™ Soffit Drip

Page 44



TWWJ: Tru-Weep™ Vertical Control Joint

Page 45



TWWF: Tru-Weep™ Window Head Flashing

Page 45

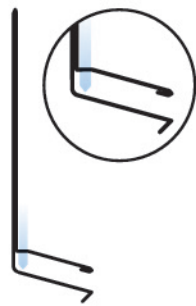

TWWT: Tru-Weep™ Weep Screenshot

Page 45



TWXLF: Tru-Weep™ XL Foundation Screenshot

Page 46



VMS: Vertical M-Slide Expansion Joint® (2 Piece)

Page 47



XDJ: Double J Control Joint

Page 48



XDV: #15 Double V Control Joint

Page 48



XEC: #30 Expansion Control Joint

Page 49



ZCJ: 093 Zinc Control Joint



See Page 10
For Details On
Measuring
Ground
&
Point-To-Point

Ordering

Knowing the names of the dimensions that comprise a vent, reveal or other metal trim can help greatly in selecting the specific product you need. When ordering, you may refer to the drawing shown to the right. Point-to-Point is the distance from one point to another "Y Dimension" and the ground "X Dimension" is the height of the point. These two dimensions are of primary concern when ordering.

Radius Shapes

- Type of Curves
- Curving Is Limited, Please Call Customer Service For Details

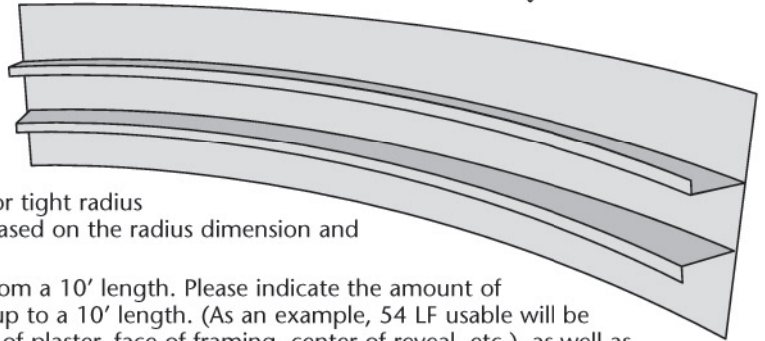

Many of Stockton's metal products can be ordered curved. For tight radius requirements, certain shapes have minimum curving ability based on the radius dimension and direction needed. Please consult us prior to ordering.

Due to the curving process, only 8 usable feet are available from a 10' length. Please indicate the amount of material required in usable feet. All material will be rounded up to a 10' length. (As an example, 54 LF usable will be rounded up to 60 LF). Please specify the point of radius (face of plaster, face of framing, center of reveal, etc.), as well as indicate the direction of the curve from the diagrams on this page.

Note: The radius is pulled towards the arrow that appears on each diagram of the types of curves available.

RADIUS – TYPE 1	RADIUS – TYPE 2	RADIUS – TYPE 3	RADIUS – TYPE 4
Arch	Reverse Arch	Outside Curve	Inside Curve
Point of Measurement	Point of Measurement	Point of Measurement	Point of Measurement
Direction of Curve	Direction of Curve	Direction of Curve	Direction of Curve
Condition – Concave	Condition – Convex	Condition – Hardway	Condition – Hardway

Materials And Finishes Guide

The product is manufactured in Copper (C), Galvanized Steel (GS), Bonderized (BN), Galvalume® (GVM), Zinc (Z), Stainless Steel (SS) or Aluminum (A). Custom shapes and radius shapes are available. Clear anodized finish and paint are not available on any metal items.

Please note not all metal items are available in stock in all the available metals or size combinations listed. Please call customer service at 1-87-Stockton to verify availability.

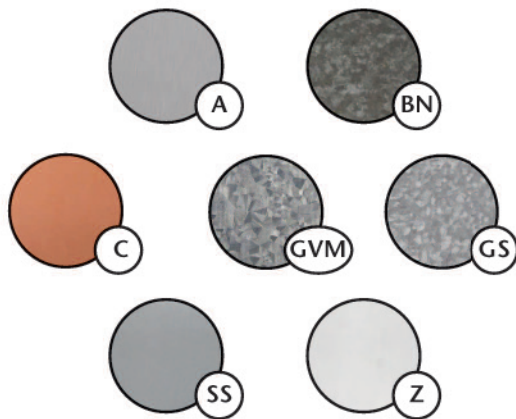

Available Materials

10ga. Galvanized Steel*	GS 10ga
12ga. Galvanized Steel*	GS 12ga
14ga. Galvanized Steel*	GS 14ga
16ga. Aluminum .050	A 16ga
16ga. Galvanized Steel*	GS 14ga
18ga. Aluminum .040	A 18ga
18ga. Galvanized Steel*	GS 18ga
20ga. Aluminum .032	A 20ga
20ga. Galvanized Steel*	GS 20ga
22ga. Aluminum .025	A 22ga
22ga. Galvanized Steel*	GS 22ga
26ga. Bonderized	BN 26ga
26ga. Copper or 16 oz (.0216)	C 26ga
26ga. Galvalume®	GVM 26ga
26ga. Galvanized Steel*	GS 26ga
26ga. PaintLoc	26ga
26ga. Stainless Steel 304#2B	SS/2 26ga
26ga. Stainless Steel 304#4	SS/4 26ga
26ga. Zinc	Z 26ga
3/16 Hot Roll Steel	HR 3/16
1/4 Hot Roll Steel	HR 1/4

*Galvanized Steel G-90, unless otherwise specified.

Available Finishes

Galvanized: "GS"

Galvanized steel is produced by submerging cold rolled steel in a molten bath of zinc. This is referred to as a "hot dip" process. Once the material is removed from the zinc bath it reacts to oxygen in the air which solidifies the bond between the zinc and the steel, leaving a "spangled" finish visible on the material. The zinc coating offers a protective layer to prevent rust and corrosion, making it ideal for HVAC, construction and other manufacturing applications.

Bonderized: "BN"

Bonderized steel is actually Galvanized G90 that has been put through a phosphate bath and has a layer of Chromate applied and dried leaving it ready to accept paint. The process produces a dull gray colored finish. Bonderized is commonly referred to as "Paint Grip"

Galvannealed (Jet Kote): "JTC"

Galvannealed Steel is carbon steel coated with zinc via a hot-dip process similar to Galvanizing. Once the steel is removed from the molten zinc it is immediately subjected to a heat treatment. This causes a reaction which results in a unique zinc-iron alloy coating on the surface of the steel.

The galvannealed surface has a non-spangled matte finish, which is very different than the highly metallic appearance of a standard galvanized coating. At times, the galvannealed coating may appear similar to uncoated cold rolled steel. One of the primary attributes of galvannealed steel is that the surface accepts paint very readily, even without pretreatment.

Electro Galvanized (Paint Loc): "PTL"

Electro Galvanized Steel is a zinc coated carbon steel similar to Galvanized and Galvannealed. The process consists of immersing the steel in a cold zinc "bath" that has an electrical current running through it. The result is a uniform layer of zinc bonded to the steel electrolytically to prevent corrosion. Key points include a uniform distribution of extremely thin zinc coating leaving a spangle free finish that welds easily and has good paintability.

Hot Rolled: "HR"

Hot Rolled Steel is the most rudimentary form of carbon steel and is found in a wide range of industries. The process involves rolling steel at high temperatures which prevents recrystallization so the steel can be easily flattened and formed. It is also typically cheaper to manufacture than other forms of carbon steel because the progression usually doesn't require a cooldown and reheating process.

Hot rolled products will have a scaly grey finish that is generally a bit rougher than other types of steel that we offer. A natural orange rust will appear on the surface of hot rolled material if it remains exposed over time. This surface finish is desired/accepted by most hot rolled users.

Cold Rolled: "CR"

Cold Rolled Steel is created by rolling Hot Rolled P&O at room temperature, below its recrystallization point, to create thinner gauges and a harder surface. It then undergoes an annealing process to regain some of its ductility. In addition to improvement of mechanical properties, cold rolling results in more control over the dimensions and appearance of the finished product. You are left with a smoother, more predictable and aesthetically appealing surface.

Proper Measurement: Ground & Point-To-Point

When ordering these two dimensions are of primary concern. Here are some tips on measuring them correctly. These methods of measurement are valid for all Stockton Products materials Wire, Metal and Extruded.

Ground

Also known as outside ground "X Dimension" is the height of the highest point from the ground or base. The measurement is taken straight up/out at a 90° angle from the ground or base.

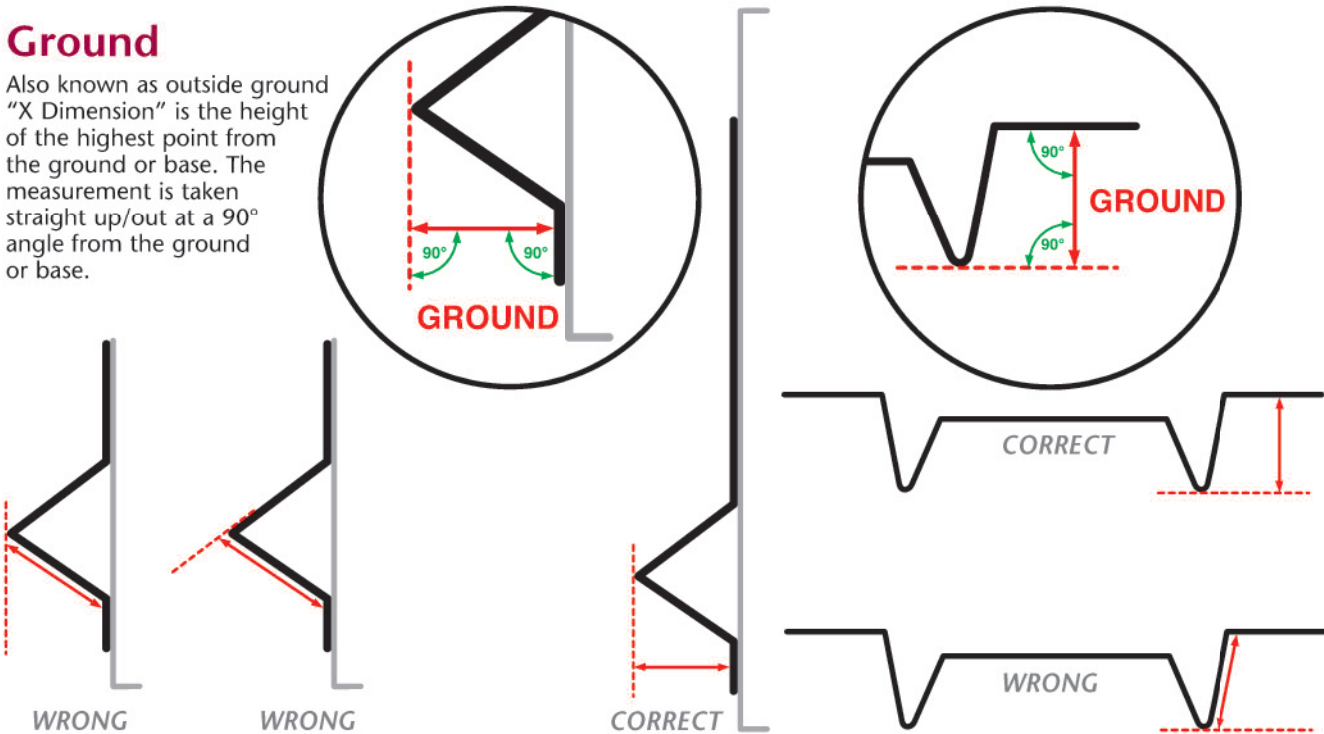

Point-To-Point

Point-To-Point is the "Y Dimension" which is the distance from one point to another, measured from the apex of the bend. The simple explanation of apex is the "top of the hill". If you place a straight edge across the points the straight edge will rest on the apex.

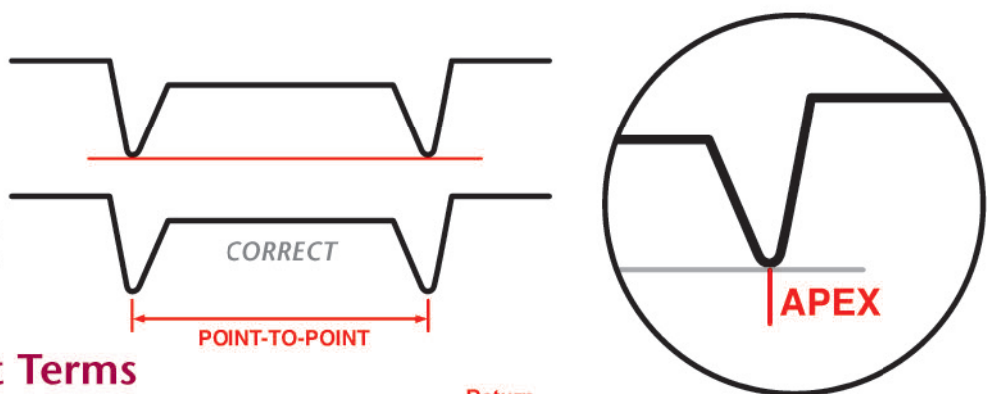

Other Important Terms

These is some additional information to help you better understand our products.

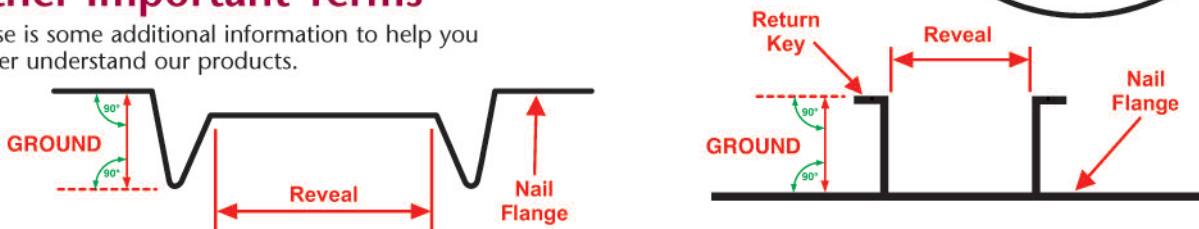

**If You Have An Questions Regarding Measuring A Product,
Feel Free To Contact Customer Service At 1-87-STOCKTON**

Soffit Vent Net Free Ventilating Area

Hole Size	Point-to-Point	Ground				
		3/8"	1/2"	3/4"	7/8"	1 3/8"
1/8"	0.75		0.59	0.59		
1/8"	1.00	1.77	1.77	1.18		
1/8"	1.50	2.36	2.36	2.36	2.36	
1/8"	2.00	4.12	4.12	3.53	3.53	3.53
1/8"	2.50	5.30	5.30	4.12	4.12	4.12
1/8"	3.00	5.89	5.89	5.89	5.89	5.89
1/8"	3.50	7.07	7.07	7.07	6.48	6.48
1/8"	4.00	8.25	8.25	8.25	7.66	7.66
1/4" (J Series)	2.00	6.28	6.28	6.28	6.28	6.28
1/4" (J Series)	2.50	7.85	7.85	7.85	7.85	7.85
1/4" (J Series)	3.00	11.00	11.00	11.00	11.00	11.00
1/4" (J Series)	3.50	12.57	12.57	12.57	12.57	12.57
1/4" (J Series)	4.00	14.14	14.14	14.14	14.14	14.14

NFVA is stated in square inches per foot of vent length.

1/8" Vent Holes

1/8" Nail Holes

Ventilation

Where determined necessary by the building official due to atmospheric or climatic conditions, enclosed attics and enclosed rafter spaces formed where ceilings are applied directly to the underside of roof rafters shall have cross ventilation for each separate space by ventilating openings protected against the entrance of rain and snow. The net free ventilating area shall not be less than 1/150 of the area of space ventilated.

Hole Reference

Vent Holes: Are for air flow. Available in 1/8" (V) or 1/4" (J)

Weep Holes: Are for water/moisture release. Available in 1/8" (W), 1/4" (J) or 1/2" (L)

Key Holes: Are to give mud/stucco something to grab on to providing a mechanical bond. Available in 1/8" (K).

Nail Holes: Are to allow easy installation by providing pre-spaced holes in the flange to secure the product. Available in 1/8" (N).

Note: Some products may offer both Vent and Weep deferent locations of the same product.



Metal Products

A variety of standard and custom metal products are available for ventilation, water management, expansion and decorative purposes.

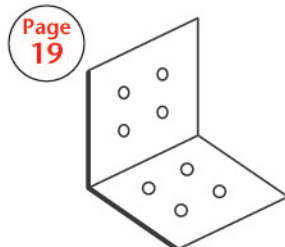

A-C: Custom Clips

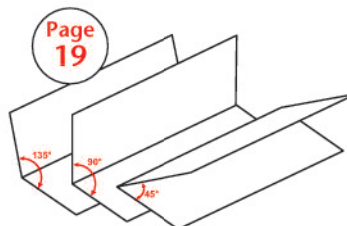

ANG: Custom Angles



AWF: Attic Wing Fascia (J-2)

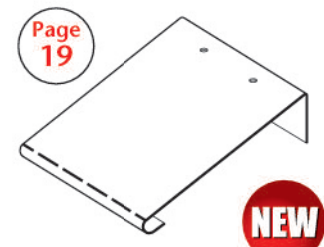

BFC: Breakaway Form Clip

NEW

Page 20



NEW

BFC: Breakaway Form Clip (Angles)

Page 20



NEW

BJB: Bullnose J Bead

Page 20

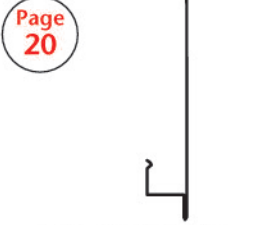

BSS: #10 Blind Stop

Page 20



C-G: Chamfer Groove

Page 21



NEW

CIC: #9 Control Joint

Page 21



CPB: Casing Plaster Bead

Page 21



CSB: Casing Starter Bead

Page 21



CSJ: Corner Slip Joint (2 Piece)

Page 22



CTM: Corner Transition Mold

Page 22



D-T: Slotted Drift Track

Page 22



DLT: Deep Leg Track

Page 22

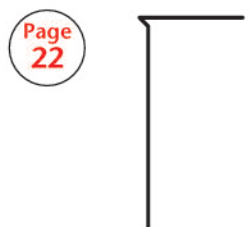

DTE: Drywall Termination Edge

Page 23

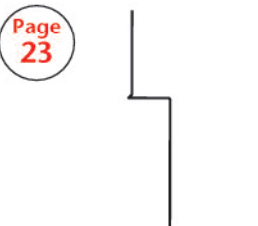

DTR: Drywall Termination Reveal

Page 23



DVG: Double V Groove

Page 23



DWR: Drywall Reveal

Page 24



NEW

DWS: DripWave® Weep Screenshot

Page 24

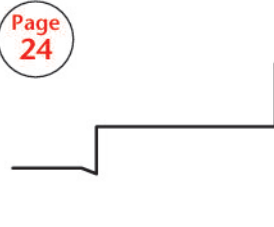

DWT: Drywall Wall Trim

Page 24



ECP: End Cap

Page 24

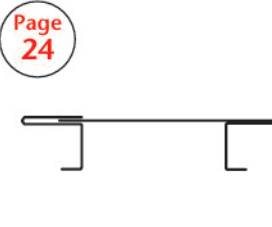

ECS: Channel Vent Screenshot (2 Piece)

Page 25



ECX: End Cap With Tapeable Flange

Page 25



EVS: Expansion Vent Screed (2 Piece)

Page 25



EWC: #40 Expansion Joint (2 Piece)

Page 25



EWR: Expansion Water-Resistant Reveal (2 Piece)

Page 26



FAS-RBR-STRAP: Strap (Rated Base Reveal)

Page 26



FDM: F Drip Mold

Page 26



FDR: F Drywall Reveal

Page 27



FEV: Flush Edge Vent

Page 27

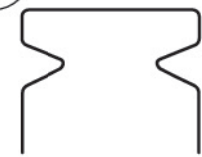

FLT: Flexible Trak

Page 27



FRM: F Reveal Mold

Page 27



FSM: Fascia Soffit Mold

Page 28

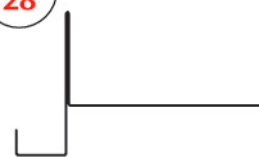

FTM: Fascia Transition Mold

Page 28

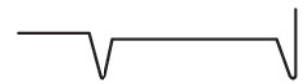

FVM: F Vent Mold

Page 28



FWC: F Water-Resistant Channel

Page 28

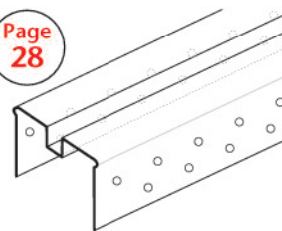

GECC: Glazing End Cap

Page 29

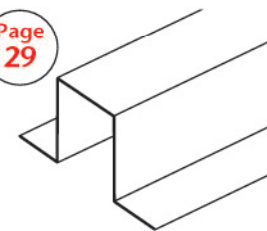

H-C: Hat Channel

Page 29

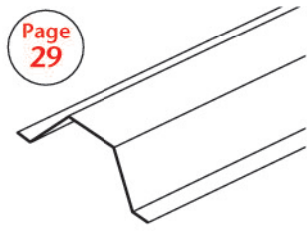

H-C/LP: Hat Channel Low Profile

Page 29



HCV: Vented Hat Channel

NEW

Page 29



ICR: Inside Corner Reveal

Page 30

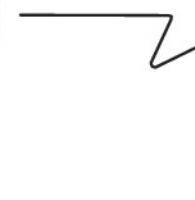

ICT: Inside Corner Control Joint

Page 30



J-B: J Bead

Page 30

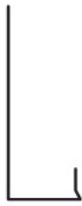

J-B88: Long Flange
J Bead 88

Page 30



JCB: J Caulking Bead

Page 31



JLC: JL Corner
(Shaft Wall)

Page 31



M-S: M Screed

Page 31

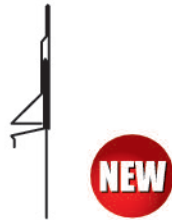

MFR: Finish Rite® M-Slide
Expansion Joint® (2 Piece)

Page 31



MSC: M-Slide Expansion
Joint® (2 Piece)

Page 32



MSX: M-Slide Expansion
Joint® (2 Piece)

Page 32



MSXE: Econo M-Slide
Expansion Joint® (2 Piece)

Page 32

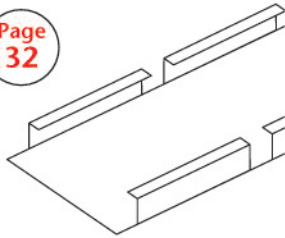

N-S: Notch Stud

Page 32



NFD: #5 Drip

Page 33



NTD: #2 Drip

Page 32

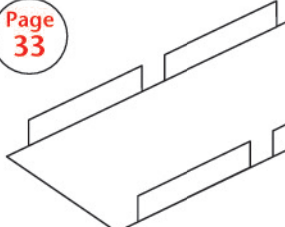

NTK: Notch Track

Page 33



NVS: Narrow V Screed

Page 33

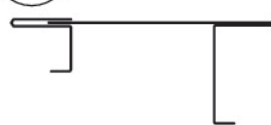

OEC: Offset Expansion
Channel Screed (2 Piece)

Page 34

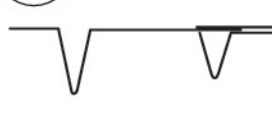

OES: Offset Expansion
Screed (2 Piece)

Page 34

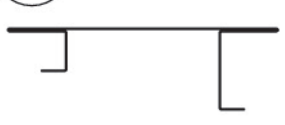

OPC: Offset Plaster
Channel Screed

Page 34

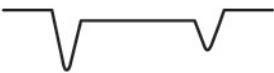

OVS: Offset Vent/Reveal
Screed

Page 34



OWC: Offset Water-
Resistant Expansion
Channel (2 Piece)

Page 35



OWS: Offset Weep
Screed

Page 35



PBS: Pointed Base
Screed

Page 35



PCS: Plaster Channel Screed

Page 35



PSV: Plywood Style Vent

Page 36



PWC: Plaster Water-Resistant Channel

Page 36

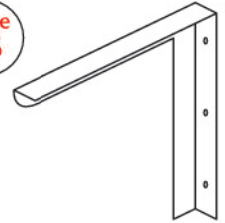

S-B: Counter Support Bracket

Page 36



SBS: BugStop® Soffit Vent

Page 36



SBW: Santa Barbara Weep Screed™

Page 37

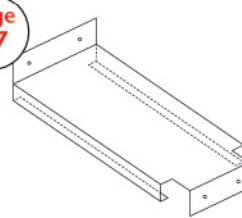

SBX: Stud Blocking

Page 37



SDE: #12 Soffit Drip Edge™

Page 37

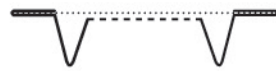

SES: EmberStop® Soffit Vent

Page 37



SFC: Short Flange Casing

Page 38



SFC88: Short Flange Casing Bead 88

Page 38



SFS: Single Flange Screed

Page 38

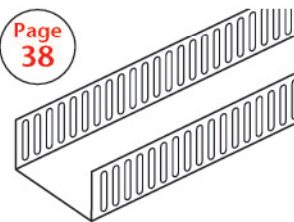

SLT: Slotted Slip Track

Page 38



SPS: Single Point Screed

Page 39



SRWS: #6 Solid Return Weep Screed

Page 39



SSF: #3 Stucco Screed Flashing

Page 39



SSM: Step Separation Mold

Page 39



SST: #36 Weep Screed

Page 40



STM: Soffit Transition Mold

Page 40

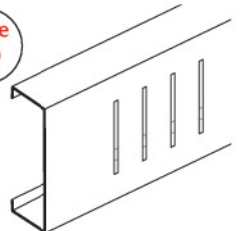

STS: Slotted Stud Sticker

Page 40

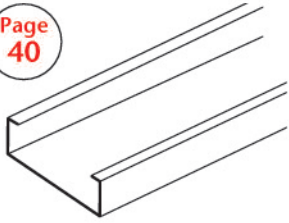

STU: Custom Stud

Page 40



SVR: Soffit Vent/Reveal Screed

Page 41

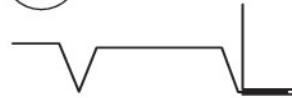

TPC: Two Piece Expansion Corner (2 Piece)

Page 41



TRC: Tru-Corner®

Page 41



TRM: T Reveal Mold

Page 41



TSF: Transition Step Flashing

Page 42



TVSS: Top Vent Stucco Screed

Page 42



TWBF: Tru-Weep™ Base Flashing

Page 42

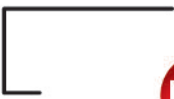

TWCB: Tru-Weep™ Casing Bead

NEW

Page 42



TWHJ: Tru-Weep™ #9 Horizontal Control Joint

NEW

Page 43



TWHJ-CI: Tru-Weep™ #9 Horizontal Control Joint

NEW

Page 43



TWM: T Water-Resistant Molding

Page 43



TWMFR: Tru-Weep™ Finish Rite® M-Slide Expansion Joint®

NEW

Page 43



TWMSC: Tru-Weep™ M-Slide Expansion Joint®

NEW

Page 44



TWMSX: Tru-Weep™ M-Slide Expansion Joint®

NEW

Page 44



TMMW: Tru-Weep™ Midwall Vent

NEW

Page 44



TWSD: Tru-Weep Soffit Drip

NEW

Page 44



TWVJ: Tru-Weep™ Vertical Control Joint

NEW

Page 45



TWWF: Tru-Weep™ Window Head Flashing

NEW

Page 45



TWWT: Tru-Weep™ Weep Screed

NEW

Page 45



NEW

TWXLF: Tru-Weep™
XL Foundation Screed

Page 45

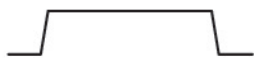

VHC: Vented Hat Screed

Page 46



NEW

VMS: Vertical M-Slide
Expansion Joint® (2 Piece)

Page 46



W-S: #7 Weep Screed

Page 46

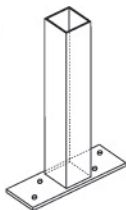

WPX-R: Wall Post
(Rectangular Base)

Page 46

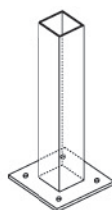

WPX-S: Wall Post
(Square Base)

Page 47

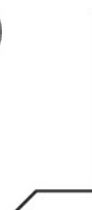

WTP: Window
Termination Point

Page 47



WVS: Wide V Screed

Page 47



WXJ: Water Management
Expansion Joint (2 Piece)

Page 47



NEW

XDJ: Double J
Control Joint

Page 48



NEW

XDV: #15 Double V
Control Joint

Page 48

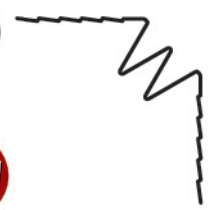

NEW

XEC: #30 Expansion
Control Joint

Page 48



XLF: #7 Extended
Weep Screed

Page 48

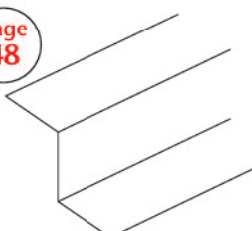

Z-B: Custom Z-Bar

Page 49

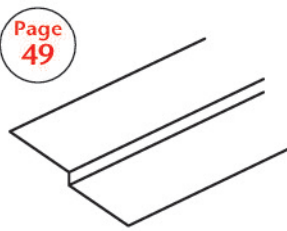

Z-B/LP: Custom Z-Bar
Low Profile

Page 49



NEW

ZCJ: 093 Zinc
Control Joint

Page 49

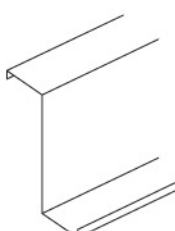

Z-P: Custom Z-Purlin

Page 49



Z-T: Z Trim

Need Wire Corners?

With more than 70 years of service to lath and plaster professionals. We offer Galvanized Steel, Stainless Steel, Plastic Nose and much more. Take a look what we can offer at the link below.

www.StocktonProducts.com/WIRE

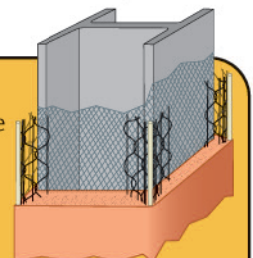



PRODUCTS™

Water Management - Quick Reference

Here is just a quick list of some of Stockton Products™ best selling water management products.

Tru-Weep™ Drainage Mat Stucco Accessories

The Tru-Weep™ stucco accessories are a series of counter flashing stucco screeds specifically designed to be used with drainage mat. Weep slots are located along the back of the sloped leg in alignment with the drainage mat to allow water to efficiently exit the stucco assembly.



TVSS: Top Vent Stucco Screed	See Page 42
TWBF: Tru-Weep™ Base Flashing	See Page 42
TWCB: Tru-Weep™ Casing Bead	See Page 42
TWHJ: Tru-Weep™ #9 Horizontal Control Joint	See Page 42
TWHJ-CI: Tru-Weep™ #9 Horizontal Control Joint	See Page 43
TWMFR: Tru-Weep™ Finish Rite® M-Slide Expansion Joint®	See Page 43
TWMSC: Tru-Weep™ M-Slide Expansion Joint®	See Page 43
TWMSX: Tru-Weep™ M-Slide Expansion Joint®	See Page 44
TWMW: Tru-Weep™ Midwall Vent	See Page 44
TWSD: Tru-Weep™ Soffit Drip	See Page 44
TWVJ: Tru-Weep™ Vertical Control Joint	See Page 44
TWWF: Tru-Weep™ Window Head Flashing.....	See Page 45
TWWT: Tru-Weep™ Weep Screed	See Page 45
TWXLF: Tru-Weep™ XL Foundation Screed	See Page 45

M-Slide Expansion Joint®

When it comes to M-Slide Expansion Joints® for moisture management, Stockton Products™ has nine styles that will move you. All two piece designs, to allow for vertical movement.

MFR: Finish Rite® M-Slide Expansion Joint® (2 Piece).....	See Page 31
MSC: M-Slide Expansion Joint® (2 Piece)	See Page 31
MSX: M-Slide Expansion Joint® (2 Piece)	See Page 32
MSXE: Econo M-Slide Expansion Joint - (2 Piece)	See Page 32
TWMFR: Tru-Weep™ Finish Rite™ M-Slide Expansion Joint®	See Page 43
TWMSC: Tru-Weep™ M-Slide Expansion Joint®	See Page 43
TWMSX: Tru-Weep™ M-Slide Expansion Joint®	See Page 44
VMS: Vertical M-Slide Expansion Joint® (2 Piece)	See Page 46
WXJ: Water Management Expansion Joint (2 Piece)	See Page 47

Superior Moisture Protection™

Stockton Products™ offers several profiles for water management and protection. One and two-piece products offer design features that mitigate the concern of moisture penetration in a horizontal condition.



EWC: #40 Expansion Joint (2 Piece)	See Page 25
EWR: Expansion Water-Resistant Reveal (2 Piece)	See Page 25
J-B: J Bead.....	See Page 30
JCB: J Caulking Bead.....	See Page 30
MFR: Finish Rite® M-Slide Expansion Joint® (2 Piece).....	See Page 31
MSC: M-Slide Expansion Joint® (2 Piece)	See Page 32
MSX: M-Slide Expansion Joint® (2 Piece)	See Page 32
OWC: Offset Water-Resistant Expansion Channel (2 Piece)	See Page 34
OWS: Offset Weep Screed	See Page 35
PWC: Plaster Water-Resistant Channel	See Page 36
SDE: #12 Soffit Drip Edge™	See Page 37
SRWS: #6 Solid Return Weep Screed	See Page 39
SSF: #3 Stucco Screed Flashing.....	See Page 39
SST: #36 Weep Screed	See Page 39
VMS: Vertical M-Slide Expansion Joint® (2 Piece)	See Page 46
W-S: #7 Weep Screed	See Page 46
WTP: Window Termination Point	See Page 47
WXJ: Water Management Expansion Joint (2 Piece)	See Page 47
XLF: #7 Extended Weep Screed	See Page 48



CUSTOM SIZES AVAILABLE!

Stockton Custom Fabrication
877-786-2587
custom@StocktonProducts.com

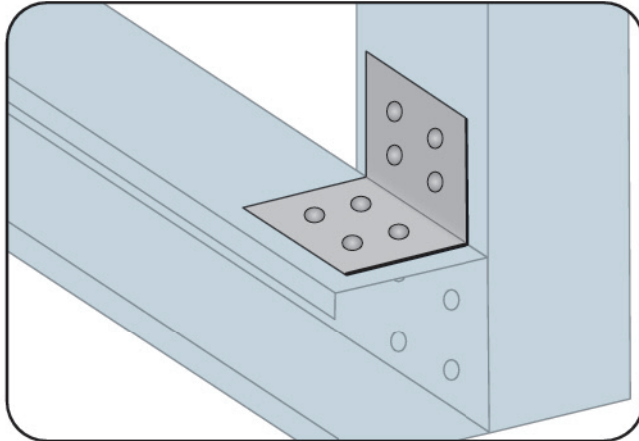

A-C: Custom Clips

- Prepunched Holes And Slotting Available
- Available in Aluminum, Copper, Galvanized Steel, Bonderized, Galvalume®, Stainless Steel or Zinc

We can custom fabricate almost any angle, bend, shape or specialty framing clip, connector or support requested. These custom products are manufactured using precision brake-forming equipment. We offer a wide selection of specialized sizes and shapes are available. Prepunched holes and specialized slotting are also available.

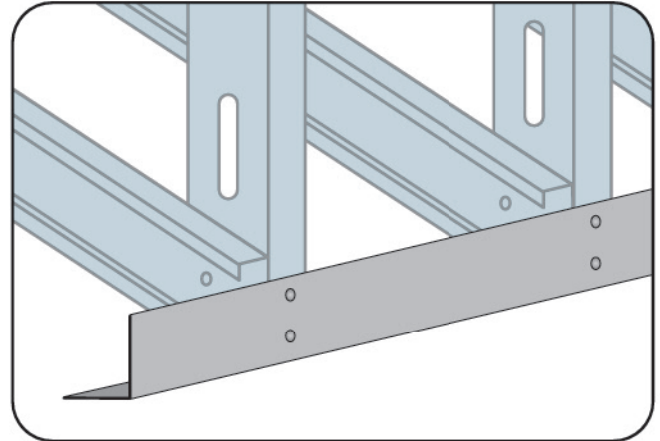

ANG: Custom Angles

- Available in Aluminum, Copper, Galvanized Steel, Bonderized, Galvalume®, Stainless Steel or Zinc

We can custom fabricate almost any angle, bend, shape or specialty framing clip, connector or support requested. These custom products are manufactured using precision brake-forming equipment. We offer a wide selection of specialized sizes and shapes are available.

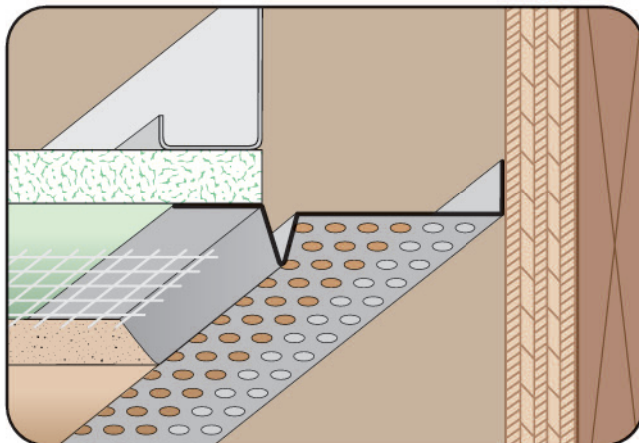

AWF: Attic Wing Fascia (J-2)

- Available With 1/8", 1/4" Vent Holes or No Vent
- Available Curved Upon Request
- Available in Aluminum, Copper, Galvanized Steel, Bonderized, Galvalume®, Stainless Steel or Zinc

Provides a ventilated finish at the juncture of soffit and fascia providing attachment by a wing in attic. Available non-vented for use as a decorative reveal upon request.

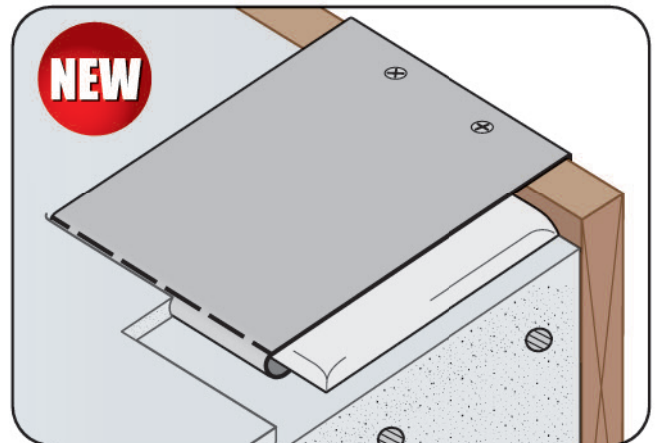

BFC: Breakaway Form Clip

- US Patent 11,035,115

The Breakaway Form Clip is designed to be temperately mounted to the wood form of your concrete pad project to hold the anchor plate squarely in place. Once the concrete is cured, simply remove the fastening nails or screws and lift up the Breakaway Form Clip and it will snap off leaving you with a nice flat anchor plate. With the optional slots you can also use Breakaway Form Clip with protruding anchor bolts.

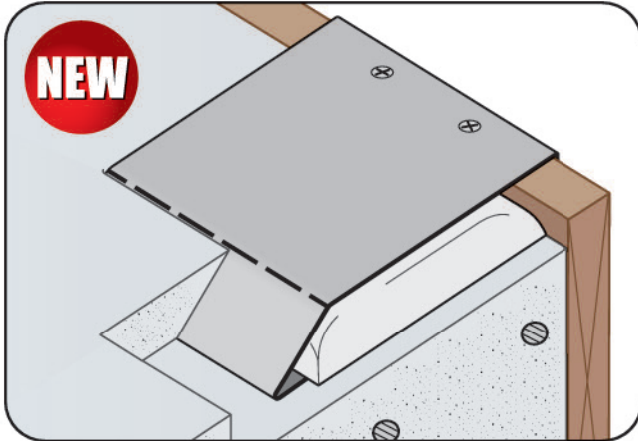

BFC: Breakaway Form Clip (Angles)

- US Patent 11,035,115

The Breakaway Form Clip is designed to be temperately mounted to the wood form of your concrete pad project to hold the anchor plate squarely in place. Once the concrete is cured, simply remove the fastening nails or screws and lift up the Breakaway Form Clip and it will snap off leaving you with a nice flat anchor plate. With the optional slots you can also use Breakaway Form Clip with protruding anchor bolts.

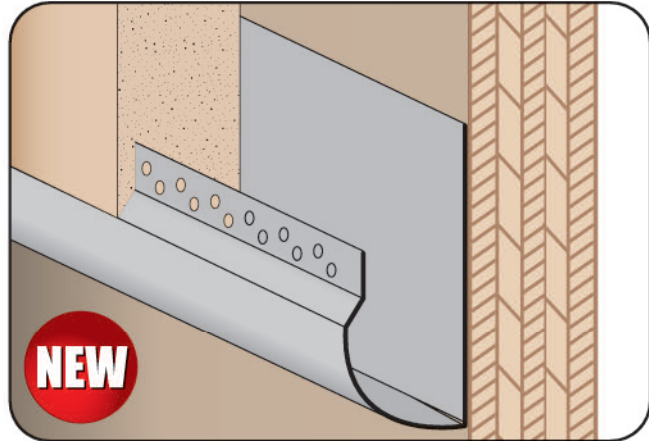

BJB: Bullnose J Bead

- Available in Aluminum, Copper, Galvanized Steel, Bonderized, Galvalume®, Stainless Steel or Zinc

A drywall stop/casing bead in a bullnose shape that provides a decorative casing around windows, doors, and at the base of walls. Keyholes in the tape flange help the drywall mud key to the trim piece.

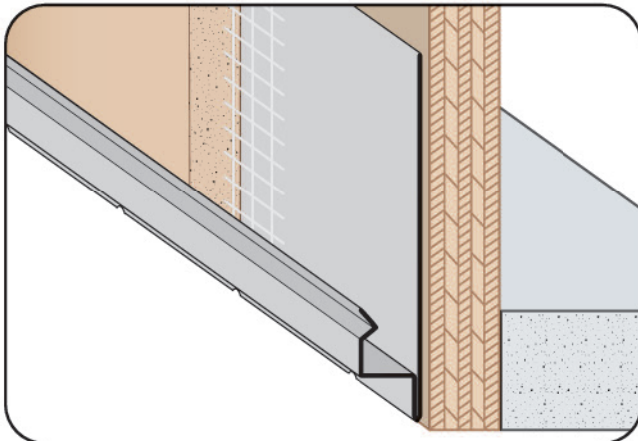

BSS: #10 Blind Stop

- Available With 1/8" Weep Holes
- Available Curved Upon Request
- Available in Aluminum, Copper, Galvanized Steel, Bonderized, Galvalume®, Stainless Steel or Zinc

A plaster stop that terminates the stucco at the base of walls or at the fascia, or fascia/soffit conditions. Also provides a drip edge and has weep holes.

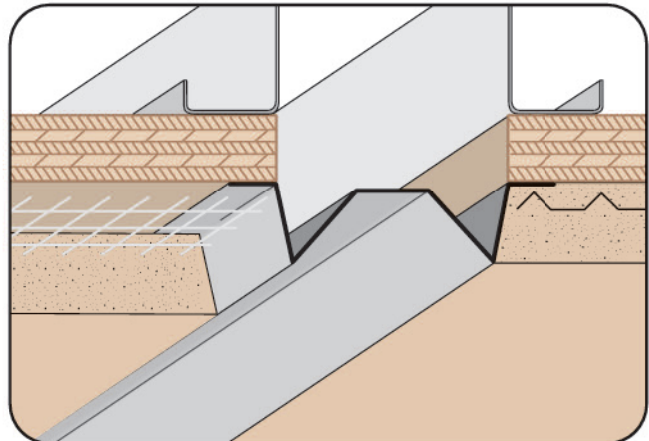

C-G: Chamfer Groove

- Available in Aluminum, Copper, Galvanized Steel, Bonderized, Galvalume®, Stainless Steel or Zinc

A unique reveal/control joint for plaster.





CUSTOM SIZES AVAILABLE!

Stockton Custom Fabrication
877-786-2587
custom@StocktonProducts.com

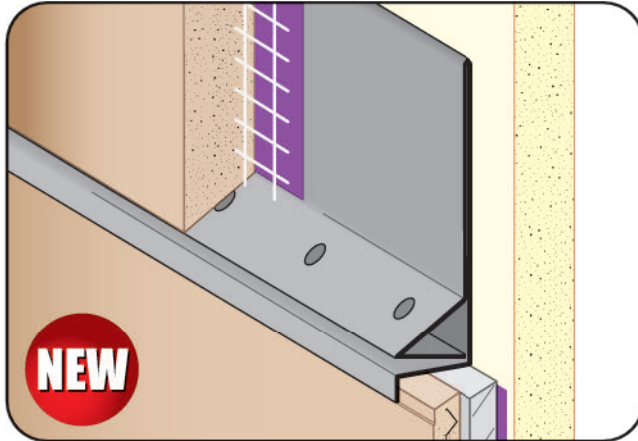

NEW

CICJ: #9 Control Joint

- Water Tested per ASTM E1105
- Superior™ Moisture Protection
- Available With 1/4" Weep Holes, No Holes or Curved Upon Request
- Available in Aluminum, Copper, Galvanized Steel, Bonderized, Galvalume®, Stainless Steel or Zinc
- US Patent 7,673,421

CICJ is a drainage point control joint for CI (continuous insulation) stucco assemblies. The ground points (X) can be customized to accommodate any combination of rigid insulation and stucco CI system. Available with or without weep holes.

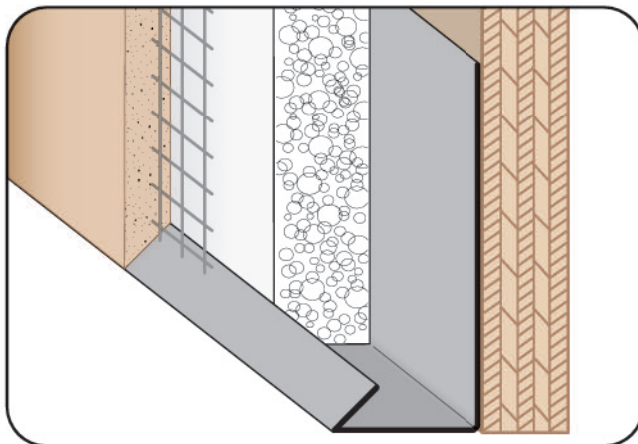

CSB: Casing Starter Bead

- Superior™ Moisture Protection
- Available With 1/8", 1/2" Weep Holes or No Holes
- Available Curved Upon Request
- Available in Aluminum, Copper, Galvanized Steel, Bonderized, Galvalume®, Stainless Steel or Zinc

A stop used as a starting track for EIFS systems.

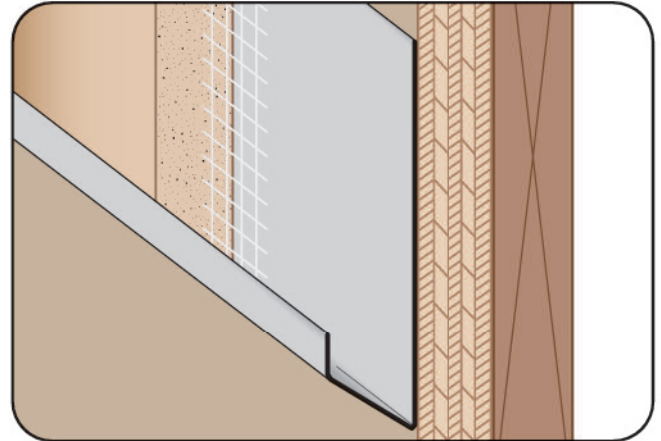

CPB: Casing Plaster Bead

- Superior™ Moisture Protection
- Available Curved Upon Request
- Available in Aluminum, Copper, Galvanized Steel, Bonderized, Galvalume®, Stainless Steel or Zinc

A plaster stop/casing bead used to terminate the stucco at the base of walls and/or where a plaster stop is required. Has a 60° angle which creates a unique look.

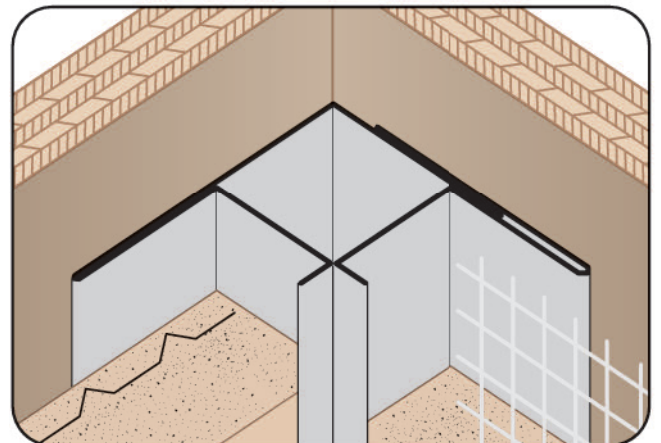

CSJ: Corner Slip Joint (2 Piece)

- Available in Aluminum, Copper, Galvanized Steel, Bonderized, Galvalume®, Stainless Steel or Zinc

Designed to facilitate movement at an inside corner condition.

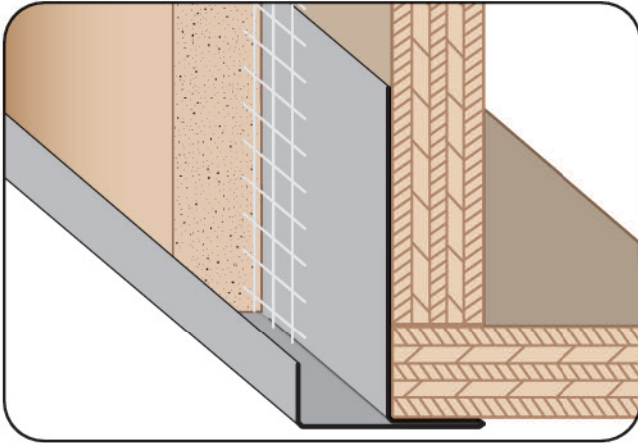

CTM: Corner Transition Mold

- Available With 1/8", 1/2" Weep Holes or No Holes
- Available in Aluminum, Copper, Galvanized Steel, Bonderized, Galvalume®, Stainless Steel or Zinc

A plaster stop used in various applications to finish an edge or bridge when using dissimilar materials. Can be used to support acoustical tile and case off windows

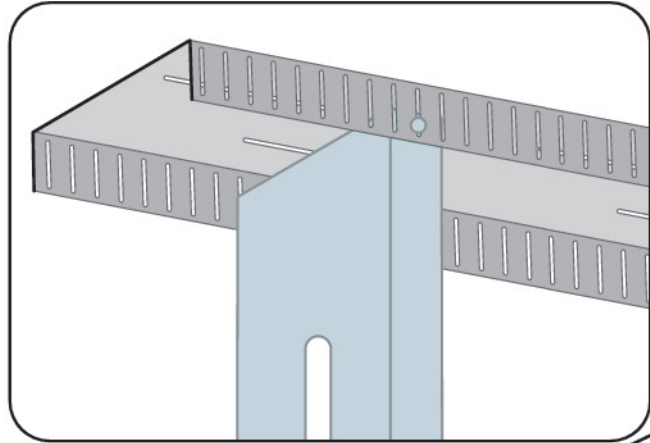

D-T: Slotted Drift Track

- Available in Galvanized Steel
- Our Slotted Drift Track is a deflection track with slots in the legs to allow for vertical deflection, and slots in the web to allow for horizontal drift when required by seismic designs. Giving you head of vertical deflection and the added horizontal drift movement.

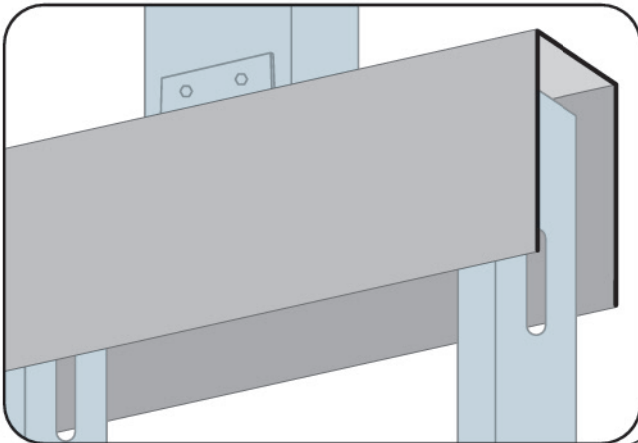
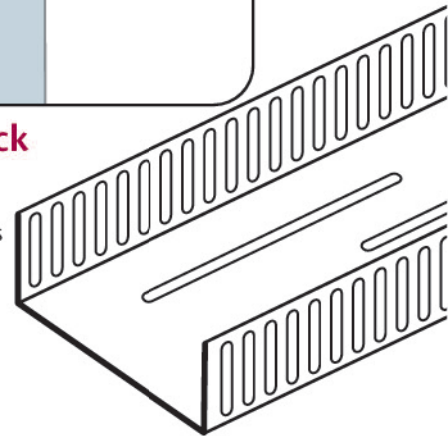

DLT: Deep Leg Track

- Available in Galvanized Steel
- The deflection track is used to align the studs vertically and the deflection of the building structure at the head of wall. Allows the top of the wall stud to float within the track legs. The wall studs are not fastened to the track.

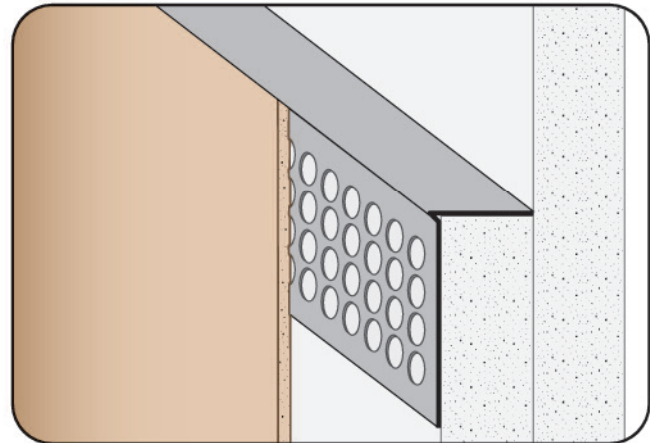
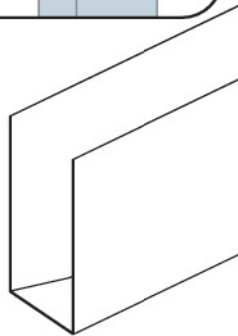

DTE: Drywall Termination Edge

- Available in Aluminum, Copper, Galvanized Steel, Bonderized, Galvalume®, Stainless Steel or Zinc
- Creates a protective and decorative edge for drywall at any termination point. Includes key holes for proper plaster adhesion.





CUSTOM SIZES AVAILABLE!

Stockton Custom Fabrication
877-786-2587
custom@StocktonProducts.com

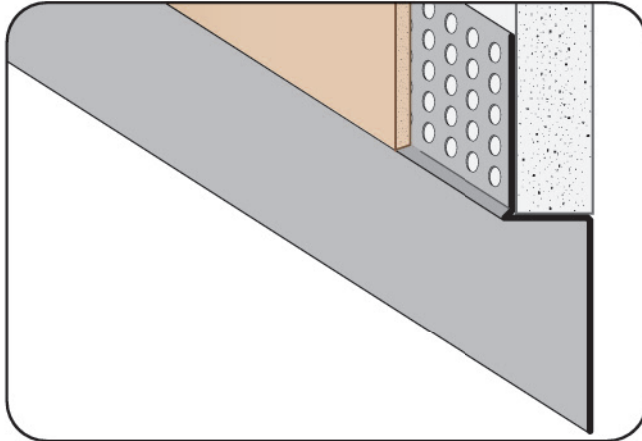

DTR: Drywall Termination Reveal

- Available Curved Upon Request
- Available in Aluminum, Copper, Galvanized Steel, Bonderized, Galvalume®, Stainless Steel or Zinc

Drywall reveal molding used at door frames and wall base application. Includes key holes for proper plaster adhesion.

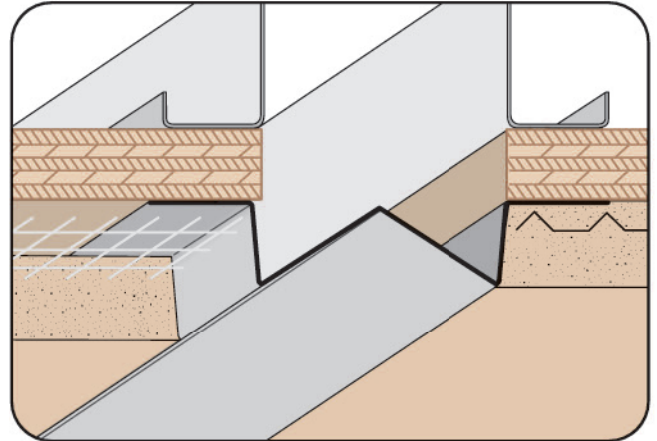

DVG: Double V Groove

- Available Curved Upon Request
 - Available in Aluminum, Copper, Galvanized Steel, Bonderized, Galvalume®, Stainless Steel or Zinc
- A plaster channel screed that creates a decorative reveal with an interesting and unique appearance.



ARCAT

Stockton Products™ Has Partnered With ARCAT® To Make Our Product Information Available To You

ARCAT is a one-stop solution for finding the right Stockton Products' for your project. With ARCAT's easy to use site you can find our product information quickly and easily download our CSI Specs, CAD and BIM files you need. Check out Stockton Products™ on ARCAT.com today!
www.stpro.us/ARCAT

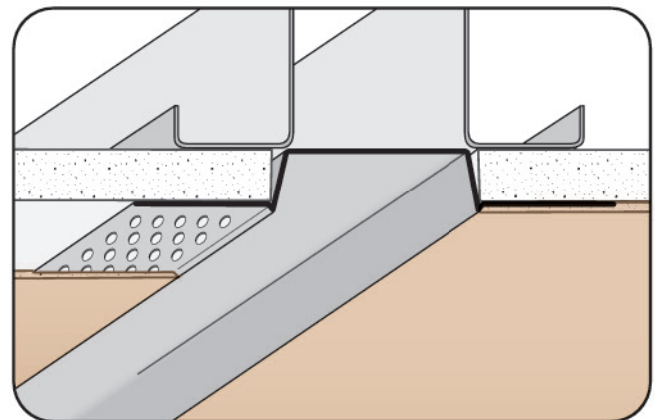

DWR: Drywall Reveal

- Available With 1/8", 1/4" Vent Holes or No Vent
 - Available Curved Upon Request
 - Available in Aluminum, Copper, Galvanized Steel, Bonderized, Galvalume®, Stainless Steel or Zinc
- Creates a decorative reveal in the drywall. The molding is attached after the drywall is installed, minimizing labor. Can be vented to permit air flow. Includes key holes for proper plaster adhesion.



BSD SpecLink

Stockton Products™ Is Now Listed On SpecLink! SpecLink Is One Of The Most Trusted Commercial Construction Specification Software In The Market. Create Specs Up To 70% Faster!

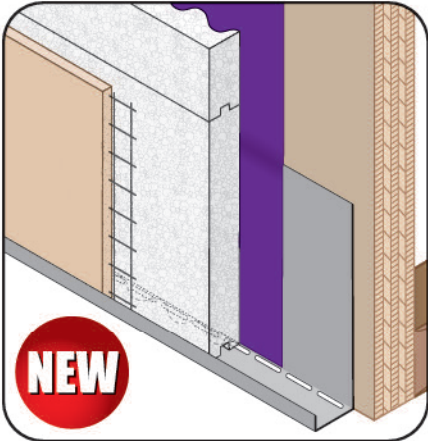

NEW

DWS: DripWave® Weep Screed

- Available in Galvanized Steel

The elongated channels at the bottom of the weep screed provide an optimal route for water to escape while providing 3/8" from the face of the insulation panel to the edge of the weep metal, in alignment with one-coat stucco application requirements.

Note: DripWave® is a registered trademark of StyTek.

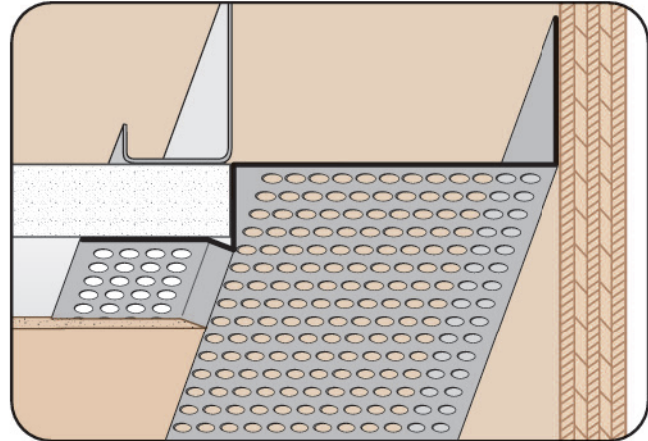

DWT: Drywall Wall Trim

- Available With Vent Holes
 - Available in Aluminum, Copper, Galvanized Steel, Bonderized, Galvalume®, Stainless Steel or Zinc
- A multi-functional drywall product that makes a smooth transition from a drywall ceiling to the wall. Includes key holes for proper plaster adhesion.

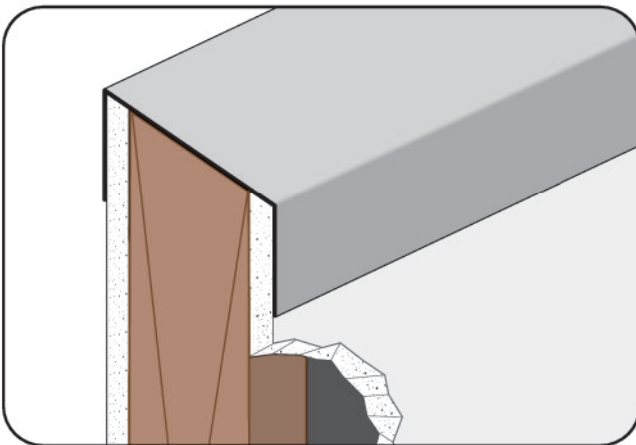

ECP: End Cap

- Available Anodized, Jet Kote (JTC) Finished
- Available in Aluminum

Used as an end cap to finish off partition walls. Standard length is 10 foot.

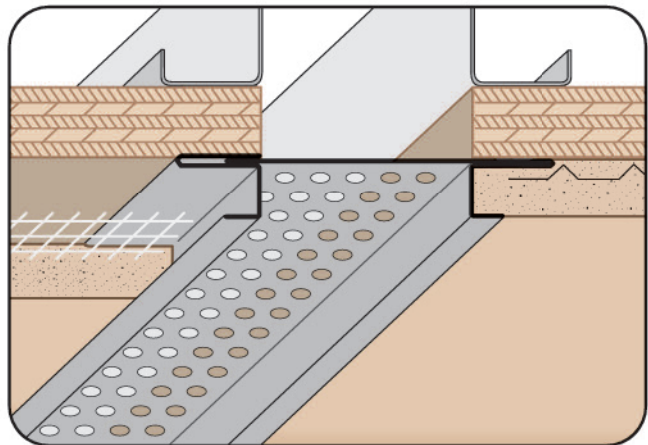
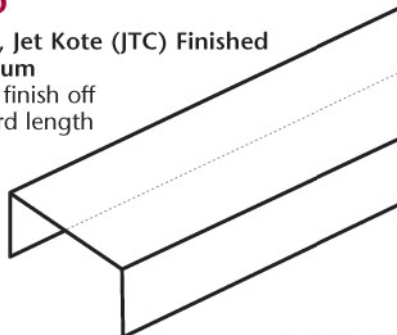

ECS: Channel Vent Screed (2 Piece)

- Available With 1/8", 1/4" Vent Holes or No Vent
 - Available in Aluminum, Copper, Galvanized Steel, Bonderized, Galvalume®, Stainless Steel or Zinc
- Adjustable version of our Plaster Channel Screed that permits movement in a double stud condition. Can be vented for air flow.





CUSTOM SIZES AVAILABLE!

Stockton Custom Fabrication
877-786-2587
custom@StocktonProducts.com

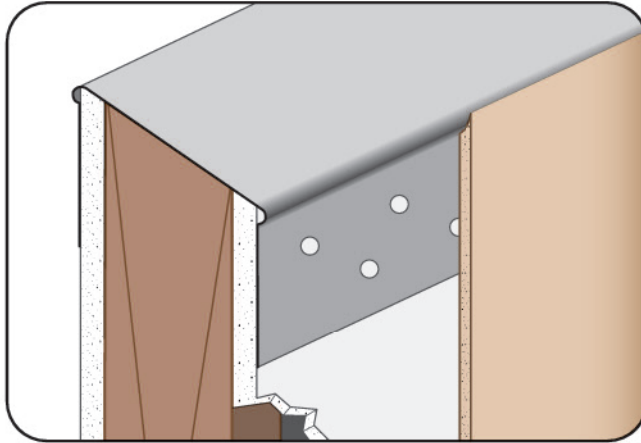

ECX: End Cap With Tapeable Flange

- Available Anodized, PaintLoc (PTL) or Jet Kote (JTC) Finished
- Available in Aluminum

Used as an end cap to finish off partition walls. Standard length is 10 foot. The ECX End Cap has holes in the taping flange for keying the drywall mud.

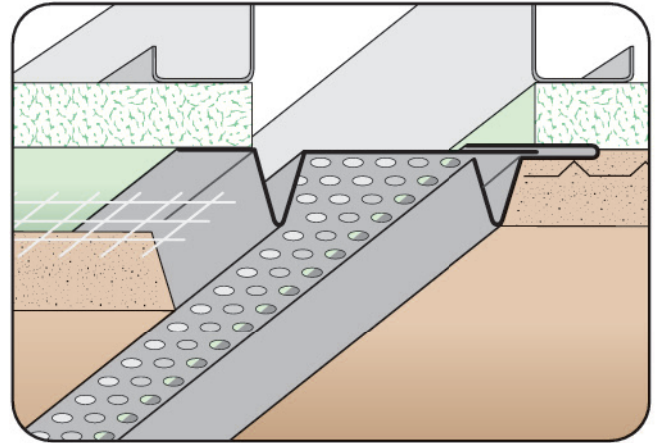
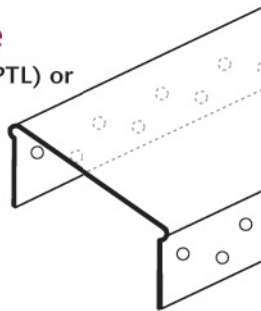

EVS: Expansion Vent Screed (2 Piece)

- Available With 1/8", 1/4" Vent Holes or No Holes
- Available in Aluminum, Copper, Galvanized Steel, Bonderized, Galvalume®, Stainless Steel or Zinc

Adjustable version of our standard vent screed that permits movement in a double stud condition while providing required airflow into space above. Can also be ordered non-vented for use as a horizontal expansion joint providing movement capabilities at a floor line.

EWC: #40 Expansion Joint (2 Piece)

- Superior™ Moisture Protection
- SolidGround® Design For Moisture Protection
- Available With 1/8" Weep Holes or No Holes

Available in Aluminum, Copper, Galvanized Steel, Bonderized, Galvalume®, Stainless Steel or Zinc
The unique hem design stops moisture penetration in a horizontal condition. The two-piece design allows for movement. Special "Step" on the attachment leg provides a locator for correct placement of the fasteners and helps keep the molding laying flat on the wall. Matching manufacturing plant miter-cut, solid-soldered inside and outside corners are available, giving you moisture management confidence throughout the entire installation.

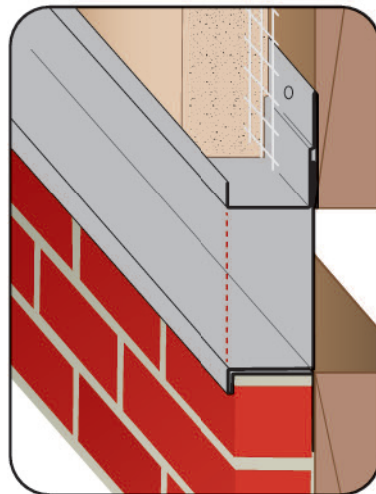

EWR: Expansion Water- Resistant Reveal (2 Piece)

- Available With 1/8" Weep Holes or No Holes
- Available in Aluminum, Copper, Galvanized Steel, Bonderized, Galvalume®, Stainless Steel or Zinc

The dual function self-aligning expansion joint provides movement capability at floor line while allow moisture to release from the top ground and locks out moisture from the bottom. Special "Step" on the attachment leg provides a locator for correct placement of the fasteners and helps keep the molding laying flat on the wall.

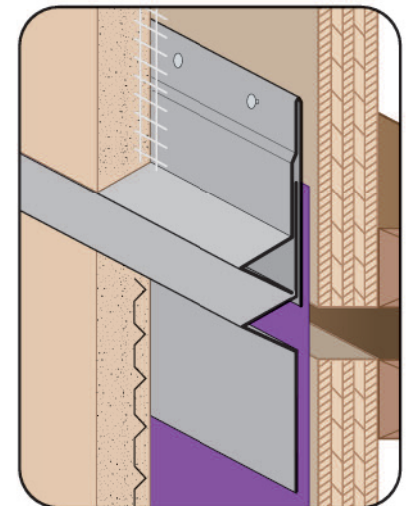



**FAS-RBR-STRAP:
Strap (Rated Base
Reveal)**

- Available in Galvanized Steel 20ga. Only
- U.S. Patent No. 9,752,318 B2

FAS-RBR-STRAP (Rated Base Reveal) is a 6" composite steel/intumescent profile that provides a fire and smoke rating according to UL-2079 for a recessed base board and listed under UL BW-S-0036. The FAS-RBR Strap is a fire rated steel/intumescent strap drywall accessory that provides fire rating for recessed base board assemblies. FAS-RBR-STRAP takes the place of drywall and maintains the UL fire rating. Provides both one and two hour fire ratings.

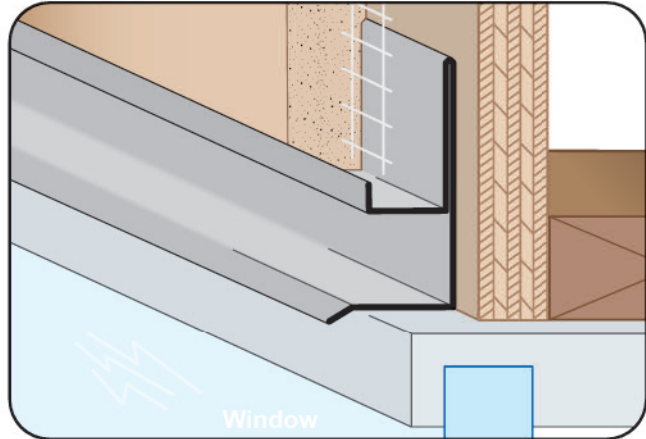
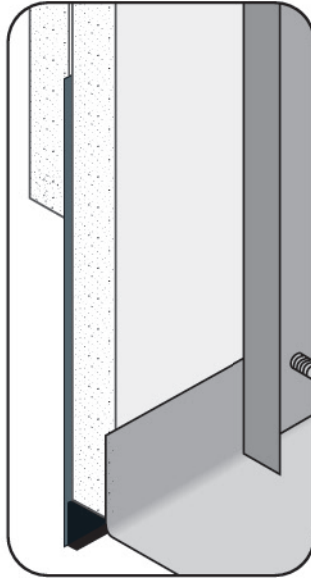

FDM: F Drip Mold

- Available With 1/8" Weep Holes or No Holes
 - Available in Aluminum, Copper, Galvanized Steel, Bonderized, Galvalume®, Stainless Steel or Zinc
- Provides a plaster stop/drip molding with an aesthetic reveal for window heads, top of doors frames and plate conditions where a drip function in desired.

**FDR:
F Drywall
Reveal**

- Available With 1/8", 1/4" Vent Holes or No Vent
 - Available Curved Upon Request
 - Available in Aluminum, Copper, Galvanized Steel, Bonderized, Galvalume®, Stainless Steel or Zinc
- Drywall reveal molding used at ceiling/wall, wall/ceiling, or base conditions. Can be vented to provide perimeter air flow. Tapes in after drywall is installed. Includes key holes for proper plaster adhesion.

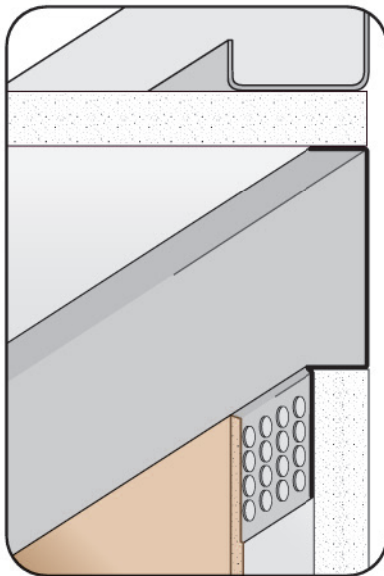

**POZ:
Pozalite®**

Pozalite® is a unique concrete/stucco enhancer that improves pumpability, strength and open-time of cementitious materials.

The use of Pozalite® means easier troweling, smoother pumping, greater productivity, better workmanship and faster clean-up.

Note: When used as designed, Pozalite® presents no safety or health hazards. As a precaution, wear respirator or dust mask to avoid inhalation of dust. Wet material may be very slippery.

Note: SDS available upon request.





CUSTOM SIZES AVAILABLE!

Stockton Custom Fabrication
877-786-2587
custom@StocktonProducts.com

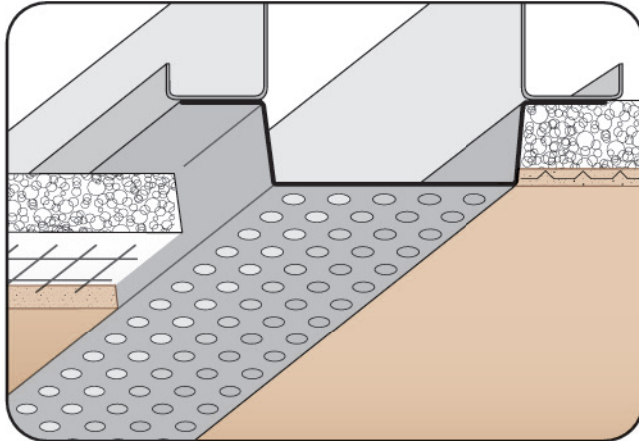

FEV: Flush Edge Vent

- Available With 1/8", 1/4" Vent Holes or No Vent
 - Available Curved Upon Request
 - Available in Aluminum, Copper, Galvanized Steel, Bonderized, Galvalume®, Stainless Steel or Zinc
- A soffit vent that provides a "Flush" reveal look.

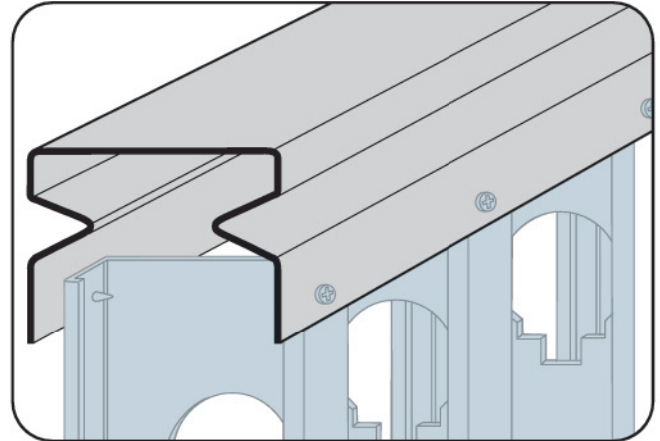

FLT: Flexible Trak

- 26 Gauge or 20 Gauge Galvanized Steel Only
- Flex Trak is designed specifically for use with non-load bearing partition walls to help reduce cracking caused by deflection. It is available in 20 gauge, G-90 galvanized steel in 3 5/8", 4" and 6" widths. Larger widths are available.

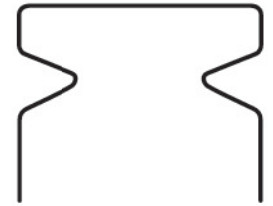

FRM: F Reveal Mold

- Available With 1/8", 1/4" Vent Holes or No Vent
 - Available With 1/8" Weep Holes or No Weep Holes
 - Available Curved Upon Request
 - Available in Aluminum, Copper, Galvanized Steel, Bonderized, Galvalume®, Stainless Steel or Zinc
- Creates a decorative reveal at wall/ceiling conditions for stucco. Can be vented for perimeter air flow. Has a return key for screeding.

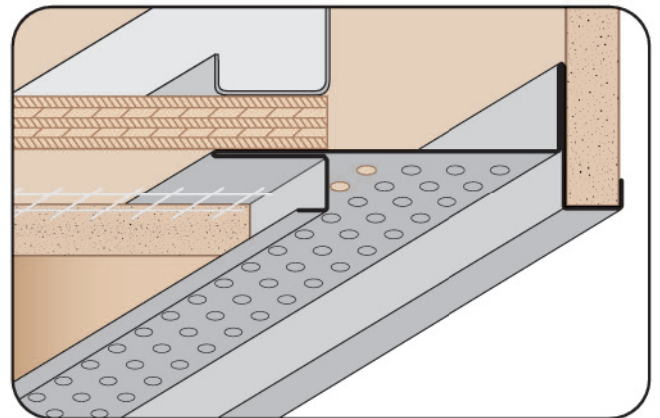
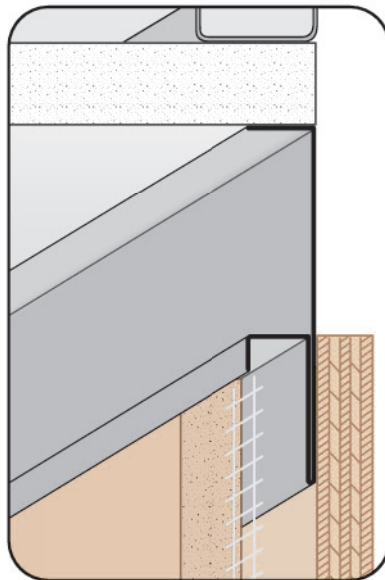

FSM: Fascia Soffit Mold

- Available With 1/8", 1/4" Vent Holes or No Vent
 - Available With 1/8" Weep Holes or No Weep Holes
 - Available Curved Upon Request
 - Available in Aluminum, Copper, Galvanized Steel, Bonderized, Galvalume®, Stainless Steel or Zinc
- Creates a decorative reveal at fascia/soffit transition providing a small overhang drip edge. Has return keys for screeding of stucco. Extended attachment flanges provides area to overlay lathing. Can be vented for perimeter airflow into space above.

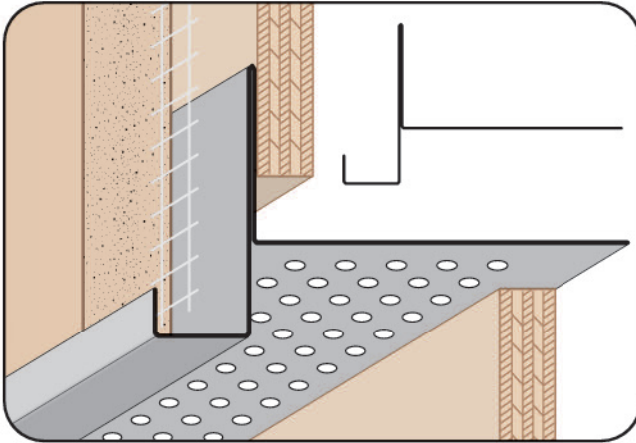

FTM: Fascia Transition Mold

- Available With 1/8", 1/4" Vent Holes or No Vent
 - Available With 1/8" Weep Holes or No Weep Holes
 - Available in Aluminum, Copper, Galvanized Steel, Bonderized, Galvalume®, Stainless Steel or Zinc
- Creates a fascia/soffit transition providing a small overhang to prevent moisture from migrating back to the soffit surface. Prevents water staining on plaster by creating a drip edge. Can be vented for perimeter airflow into space above the soffit.

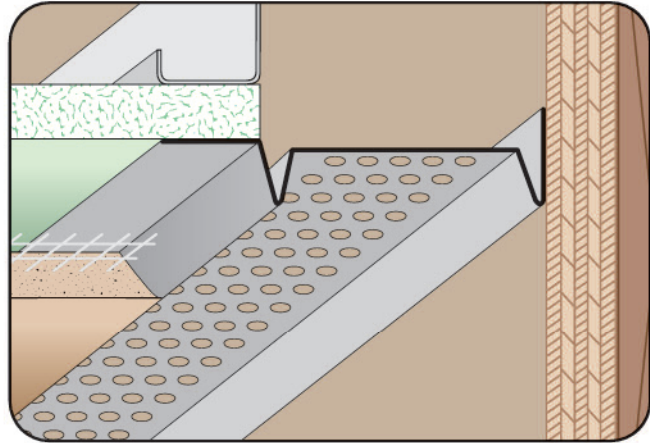

FVM: F Vent Mold

- Available With 1/8", 1/4" Vent Holes or No Vent
 - Available Curved Upon Request
 - Available in Aluminum, Copper, Galvanized Steel, Bonderized, Galvalume®, Stainless Steel or Zinc
- F-vent designed to butt against walls on one side with an extended attachment flange providing perimeter airflow. Available non-vented for use as a decorative reveal upon request.

**FWC:
F Water-Resistant Channel**

- Superior™ Moisture Protection
 - SolidGround® Design For Moisture Protection
 - Available in Aluminum, Copper, Galvanized Steel, Bonderized, Galvalume®, Stainless Steel or Zinc
- One-piece design feature mitigates the concern of moisture penetration in a horizontal application. Matching factory miter-cut, solid-soldered inside and outside corners are available, giving you moisture management confidence throughout the entire installation.

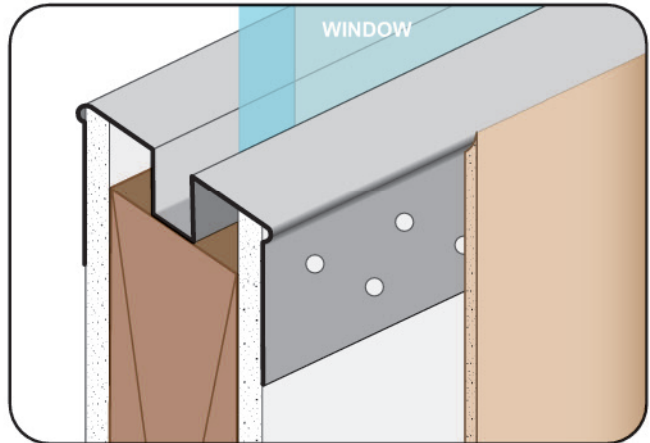
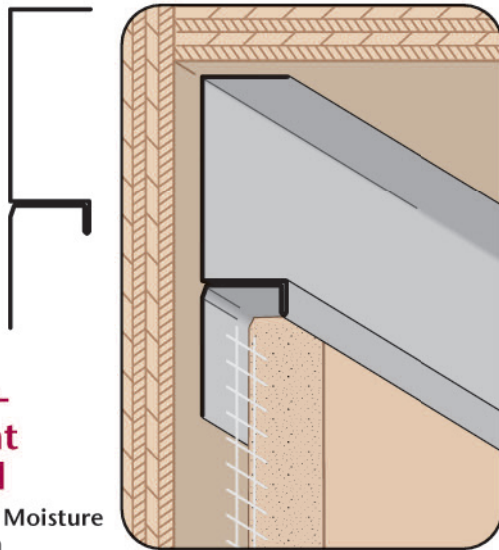

GECX: Glazing End Cap

- Available Anodized, PaintLoc (PTL) or Jet Kote (JTC) Finished
 - Available in Aluminum
- Used as an end cap to hold glass. Standard length is 10 foot. The GECX Glazing End Cap has holes in the taping flange for keying the drywall mud.
- Note:** Reveal width depends on glass thickness. Please specify Z dimensions width and depth of reveal.

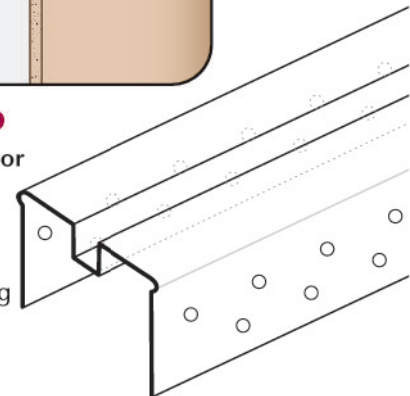



CUSTOM SIZES AVAILABLE!

Stockton Custom Fabrication
877-786-2587
custom@StocktonProducts.com

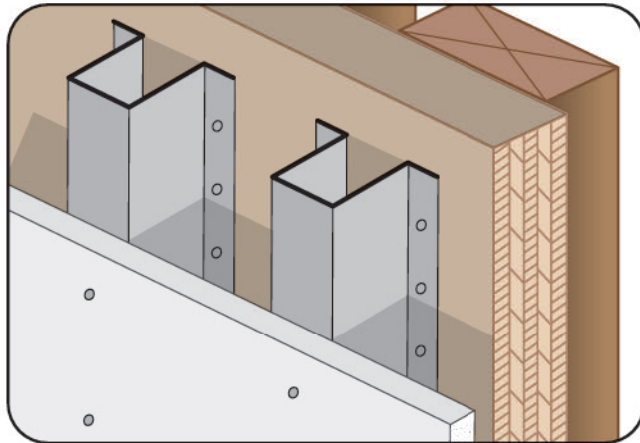

H-C: Hat Channel

- Available in Aluminum, Copper, Galvanized Steel, Bonderized, Galvalume®, Stainless Steel or Zinc

These 90° Hat Channel are hat-shaped framing component used to space out masonry walls and ceiling assemblies. In concrete wall applications, furring channel is installed vertically to the wall surface using concrete nails or power-driven fasteners. Drywall panels are then attached to the Hat Channels.

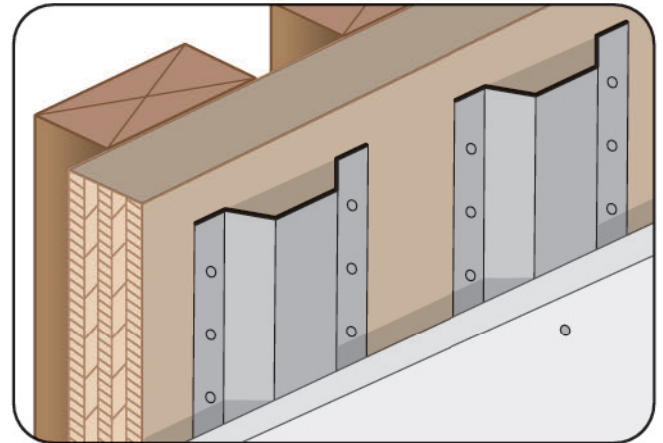

H-C/LP: Hat Channel Low Profile

- Available in Aluminum, Copper, Galvanized Steel, Bonderized, Galvalume®, Stainless Steel or Zinc

Similar to the hat Channel the Hat Channel Low Profile is designed to give less spacing. These 110° Hat Channel are framing component used to space out masonry walls and ceiling assemblies. In concrete wall applications, furring channel is installed vertically to the wall surface using concrete nails or power-driven fasteners. Exterior panels are then attached to the Hat Channels.

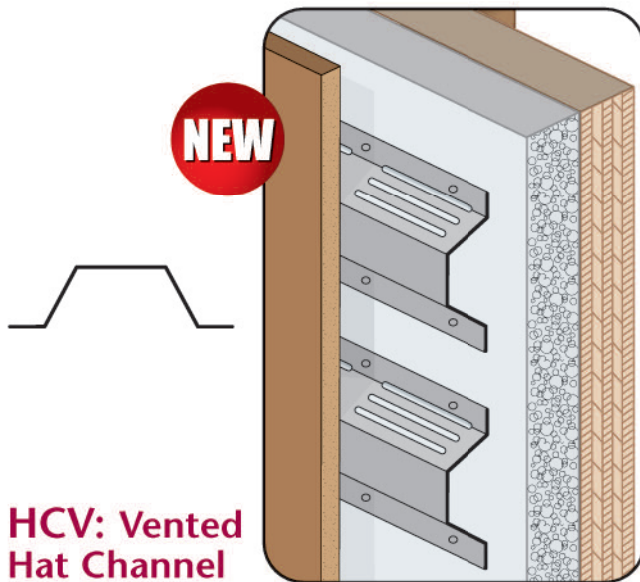

HCV: Vented Hat Channel

- Available in Aluminum, Copper, Galvanized Steel, Bonderized, Galvalume®, Stainless Steel or Zinc

The Vented Hat Channel is designed to provide spacing between insulation and the exterior cladding. This space allows for both ventilation and moisture drainage.

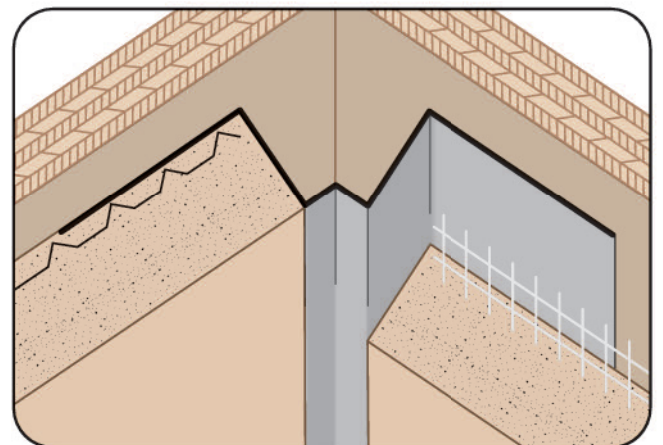

ICR: Inside Corner Reveal

- Available in Aluminum, Copper, Galvanized Steel, Bonderized, Galvalume®, Stainless Steel or Zinc

Use this product when needing a straight, clean inside edge (control joint) at a vertical or horizontal corner providing a straight edge decorative reveal. Provides a decorative reveal at an inside corner condition.

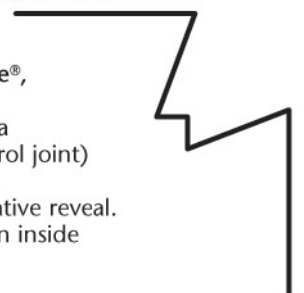

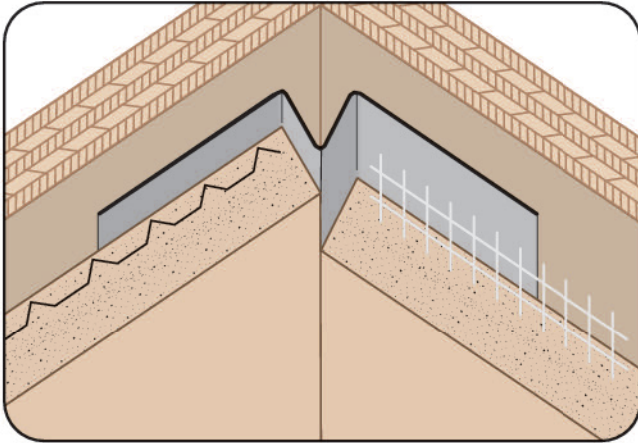

ICT: Inside Corner Control Joint

- Available in Aluminum, Copper, Galvanized Steel, Bonderized, Galvalume®, Stainless Steel or Zinc
- Use this product when needing a straight, clean inside edge at a vertical or horizontal corner. Provides a straight edge where soffit and wall meet.
- Note:** Attach panel per manufacturer's recommended installation instructions.

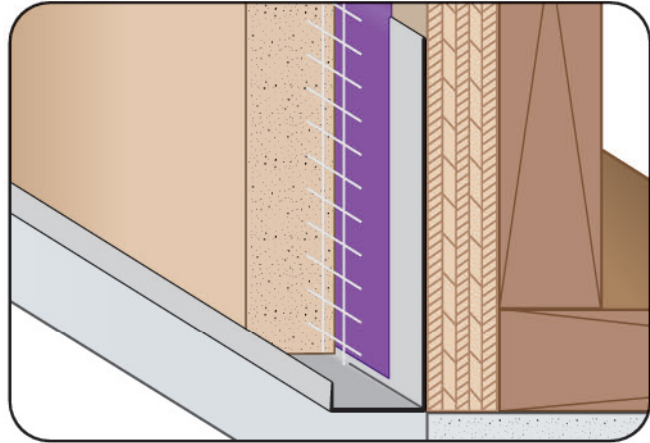

J-B: J Bead

- Superior™ Moisture Protection
 - Available With 1/8", 1/2" Weep Holes or No Weep
 - Available Curved Upon Request
 - Aluminum, Copper, Galvanized Steel, Bonderized, Galvalume®, Stainless Steel or Zinc
- Standard plaster stop/casing bead for terminating stucco. Has a return key for finishing.

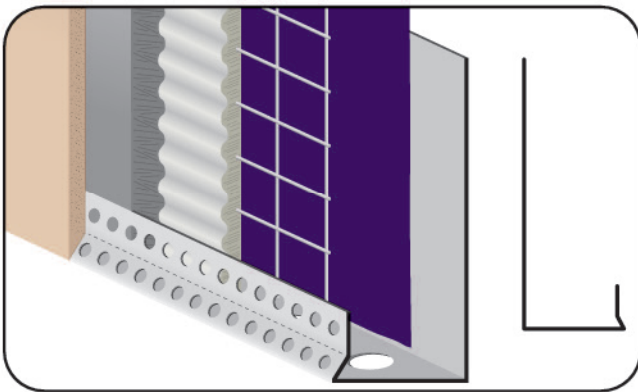

J-B88: Long Flange J Bead 88

- Patent Pending
- Includes 1/2" Weep Holes
- Available in Galvanized Steel, Galvalume® or Aluminum

Similar to the new SFC88 Short Flange "Finish Rite™" plaster trim, the J-B88 Long Flange J bead provides all the same features of controlling the brown coat thickness, but has a 3 1/2" nail flange and 1/2" diameter weep holes for those conditions where a weep function is required. No more excessive plaster build up! Control your finish, control your cost! Special sizes available. Please contact us for more information.

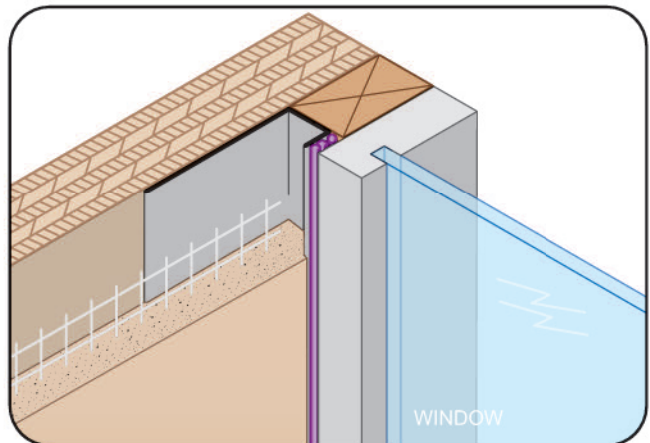

JCB: J Caulking Bead

- Superior™ Moisture Protection
 - Available Curved Upon Request
 - Available in Aluminum, Copper, Galvanized Steel, Bonderized, Galvalume®, Stainless Steel or Zinc
- Standard plaster stop/casing bead for terminating stucco with an extended return key for caulking



CUSTOM SIZES AVAILABLE!

Stockton Custom Fabrication
877-786-2587
custom@StocktonProducts.com

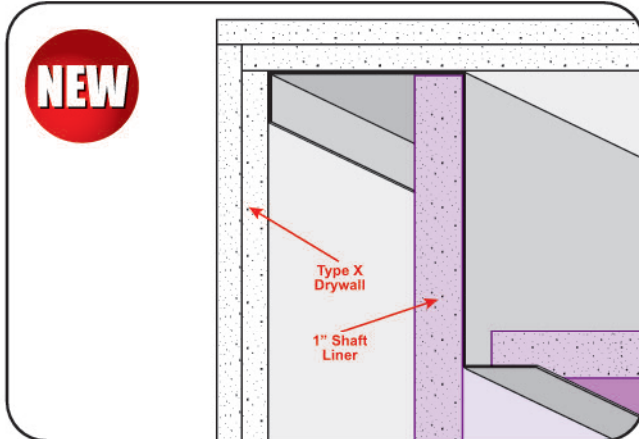

NEW

JLC: JL Corner (Shaft Wall)

- Eliminates Multi-Piece Shaft Wall Corner Construction
- Eliminates Air Gaps In Shaft Wall Corners
- Provides Greater Structural Integrity For Corners
- Custom Lengths Available Up To 14' Long
- Available in 20ga, 18ga, and 16ga Galvanized Steel

Stockton Products JL Corner is single piece metal framing member designed for outside corners within shaft wall assemblies.

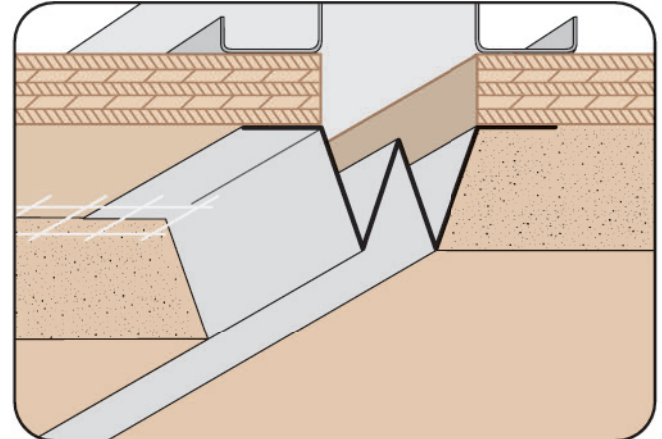

M-S: M Screed

- Available in Aluminum, Copper, Galvanized Steel, Bonderized, Galvalume®, Stainless Steel or Zinc
- A versatile control joint used primarily to relieve cracking. Provides a decorative reveal.



NEW

MFR: Finish Rite® M-Slide Expansion Joint® (2 Piece)

- Superior Moisture Protection™
- Available With 1/4" or 1/2" Weep Holes or No Holes
- Available in Aluminum, Copper, Galvanized Steel, Bonderized, Galvalume®, Stainless Steel or Zinc
- US Patent 7,673,421 B2

The dual function self-aligning expansion joint provides movement capability at floor line while allowing moisture to release from the top ground and lock out moisture from the bottom. Special "Step" on the attachment leg provides a locator for correct placement of the fasteners and helps keep the molding laying flat on the wall. Provides 1" of vertical movement.

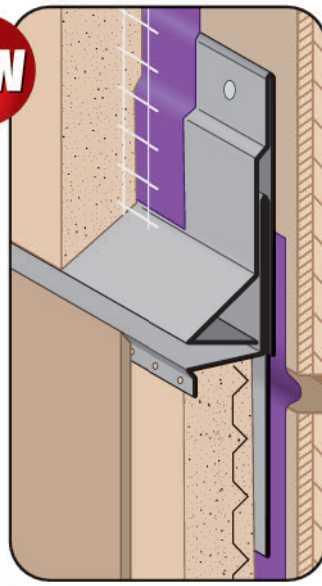

MSC: M-Slide Expansion Joint® (2 Piece)

- Does Not Have A Plaster Return Key
- Superior Moisture Protection™
- Available With 1/4" Weep Holes or No Holes
- Available in Aluminum, Copper, Galvanized Steel, Bonderized, Galvalume®, Stainless Steel or Zinc
- US Patent 7,673,421 B2

The self-aligning, dual function M-Slide expansion joint provides movement capability at the floor line while providing a water management system that will allow moisture to release from the top ground and lock out moisture from the bottom ground.

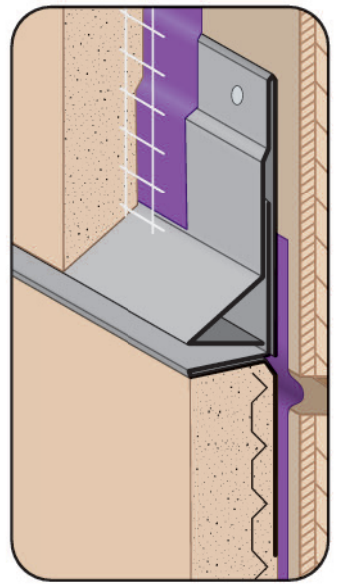



MSX: M-Slide Expansion Joint® (2 Piece)

- Superior Moisture Protection™
- SolidGround® Design For Moisture Protection
- Available With 1/4" Weep Holes or No Holes
- Available in Aluminum, Copper, Galvanized Steel, Bonderized, Galvalume®, Stainless Steel or Zinc
- US Patent 7,673,421 B2

The dual function self-aligning expansion joint provides movement capability at floor line while allowing moisture to release from the top ground and lock out moisture from the bottom. Special "Step" on the attachment leg provides a locator for correct placement of the fasteners and helps keep the molding laying flat on the wall. Provides 1" of vertical movement.

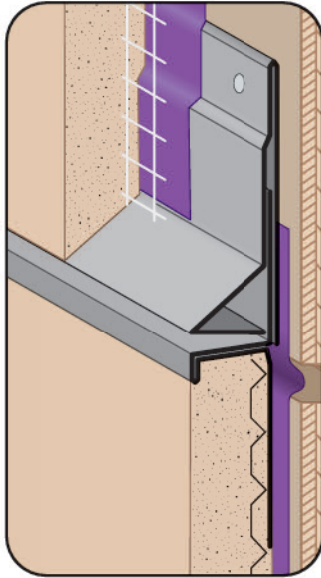

MSXE: Econo M-Slide Expansion Joint® (2 Piece)

- Available With 1/4" or 1/2" Weep Holes or No Holes
- Available in Aluminum, Copper, Galvanized Steel, Bonderized, Galvalume®, Stainless Steel or Zinc

Econo M-Slide Expansion Joint® is a version of the M-Slide Expansion Joint® product line that does not have the additional back leg behind the sloped screed along the upper portion of the profile. The dual function self-aligning expansion joint provides movement capability at floor line while allowing moisture to release from the top ground and lock out moisture from the bottom.

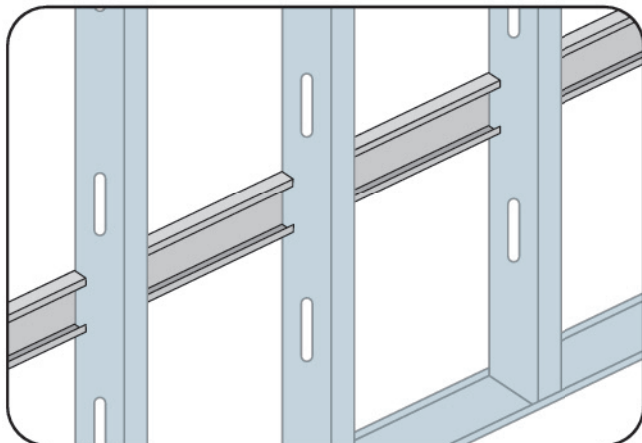
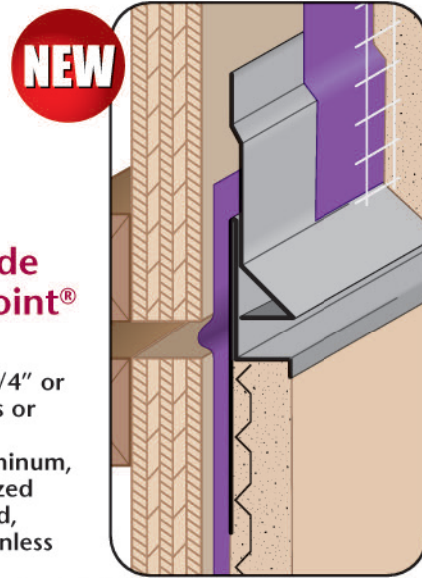

N-S: Notch Stud

- Available in Galvanized Steel
- Similar to Notch Track, our Notched Stud is used for floor joist blocking or horizontal backing in walls to allow support mounting various items to the walls. The major difference is Notched Stud features additional structural support to provide a strong mounting surface.

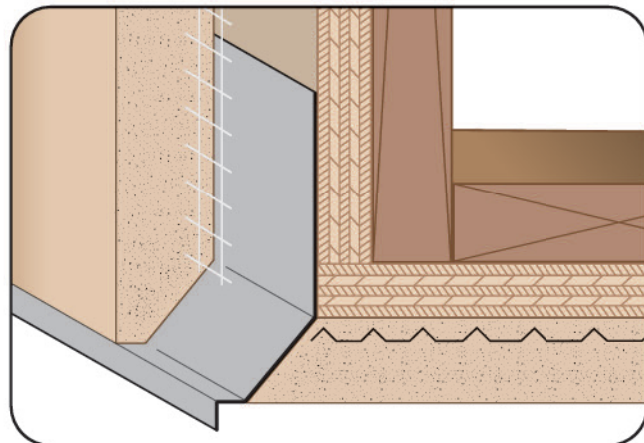
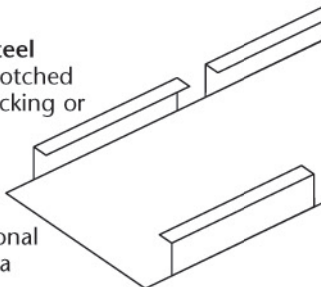

NFD: #5 Drip

- Superior™ Moisture Protection
 - Available With 1/2" Key Holes or No Holes
 - Available in Aluminum, Copper, Galvanized Steel, Bonderized, Galvalume®, Stainless Steel or Zinc
- A drip screed that helps align the soffit to give it a clean, straight edge at the fascia/soffit line.
- Note:** Curving this item is limited. Please consult customer service for more information.



CUSTOM SIZES AVAILABLE!

Stockton Custom Fabrication
877-786-2587
custom@StocktonProducts.com

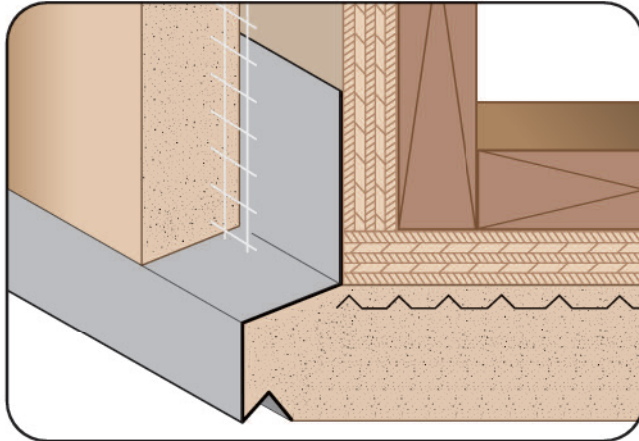

NTD: #2 Drip

- No Weep Holes
- Available Curved Upon Request
- Available in Aluminum, Copper, Galvanized Steel, Bonderized, Galvalume®, Stainless Steel or Zinc

A plaster drip screed that helps align the soffit to give it a clean, straight edge at the fascia/soffit line. Provides a unique 3/4" "flush" reveal at the fascia.

Note: Curving this item is limited. Please consult customer service for more information.

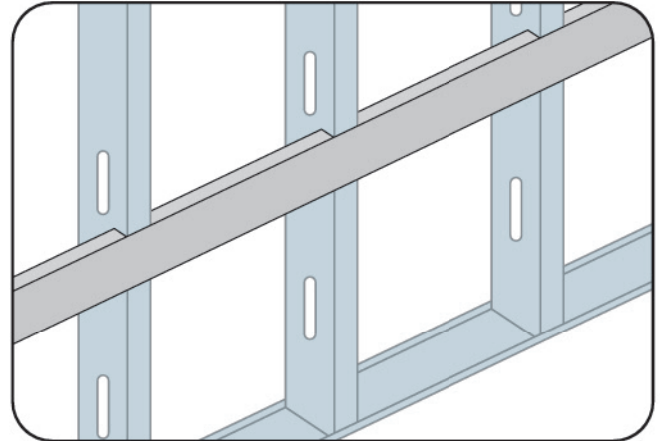

NTK: Notch Track

- Available in Galvanized Steel
- Used for floor joist blocking or horizontal backing in walls to allow support mounting various items to the walls.

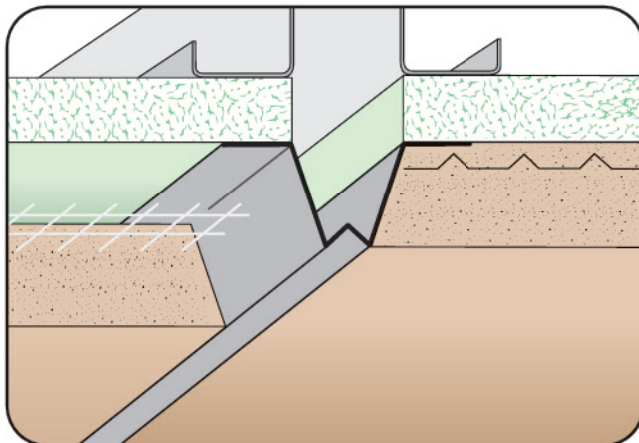
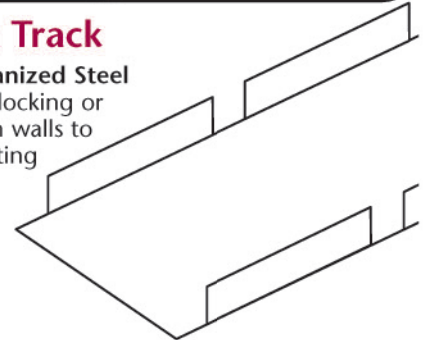

NVS: Narrow V Screed

- Available With Key Holes or No Holes
- Available in Aluminum, Copper, Galvanized Steel, Bonderized, Galvalume®, Stainless Steel or Zinc

A control joint with a minimal reveal. Available with key holes in the nailing flange for better plaster adhesion.

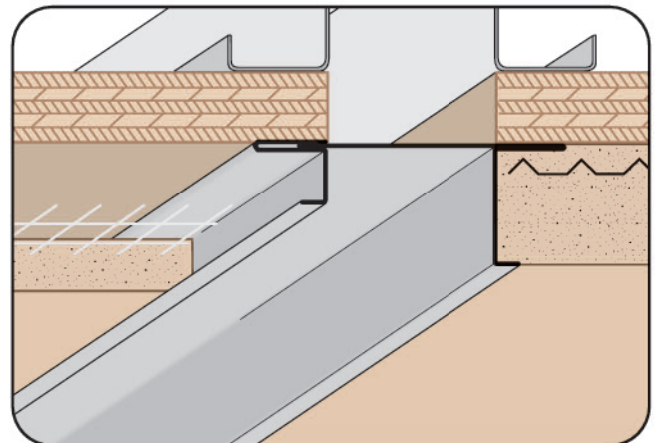

OEC: Offset Expansion Channel Screed (2 Piece)

- Available With 1/8", 1/4" Vent Holes or No Holes
- Available in Aluminum, Copper, Galvanized Steel, Bonderized, Galvalume®, Stainless Steel or Zinc

Two piece adjustable version of our Offset Plaster Channel Screed that permits movement in a double stud condition or at a floor line.



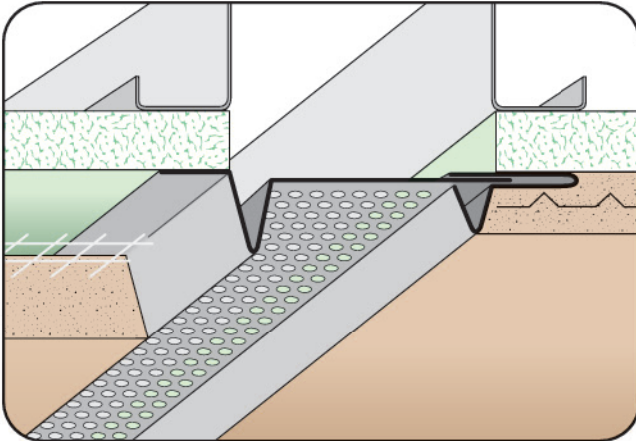

OES: Offset Expansion Screed (2 Piece)

- Available With 1/8", 1/4" Vent Holes or No Holes
- Available in Aluminum, Copper, Galvanized Steel, Bonderized, Galvalume®, Stainless Steel or Zinc

Adjustable version of our Offset Reveal Screed that permits movement in a double stud condition and at floor lines.

Available vented for air flow.

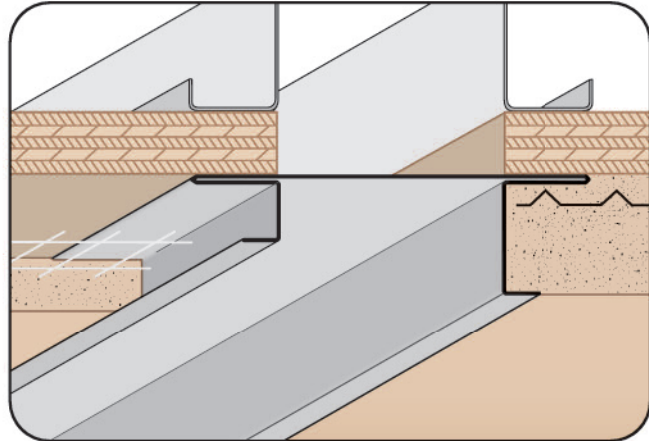

OPC: Offset Plaster Channel Screed

- Available With 1/8", 1/4" Vent Holes or No Holes
- Available Curved Upon Request
- Available in Aluminum, Copper, Galvanized Steel, Bonderized, Galvalume®, Stainless Steel or Zinc

A channel screed style reveal molding with return keys for screeding. Provides a longer leg on one side for dissimilar depths of materials, such as EIFS. Available with 1/8" weep holes.

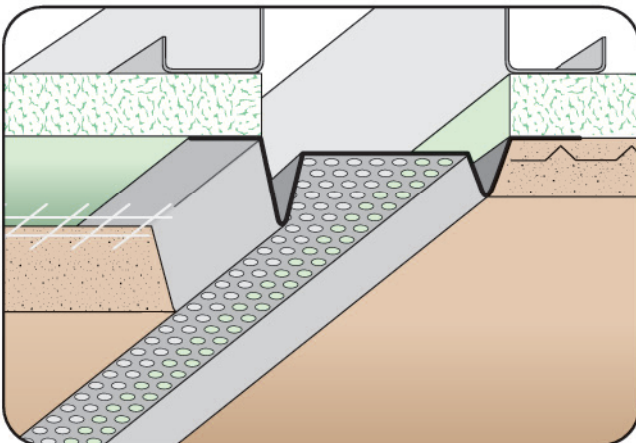
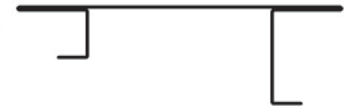

OVS: Offset Vent/Reveal Screed

- Available With 1/8", 1/4" Vent Holes or No Holes
- Available Curved Upon Request
- Available in Aluminum, Copper, Galvanized Steel, Bonderized, Galvalume®, Stainless Steel or Zinc

A variation of our standard vent screed which provides a larger depth on one side to accommodate materials of dissimilar depths.



OWC: Offset Water-Resistant Expansion Channel (2 Piece)

- Superior™ Moisture Protection
- Available With 1/8" Weep Holes or No Holes
- SolidGround® Design For Moisture Protection
- Available in Aluminum, Copper, Galvanized Steel, Bonderized, Galvalume®, Stainless Steel or Zinc

The OWC is the same as the EWC except that it offers two leg lengths for situations where 2 dissimilar depths come together. Special "Step" on the attachment leg provides a locator for correct placement of the fasteners and helps keep the molding laying flat on the wall.

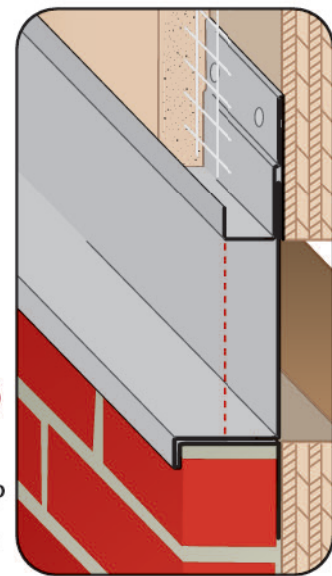



CUSTOM SIZES AVAILABLE!

Stockton Custom Fabrication
877-786-2587
custom@StocktonProducts.com

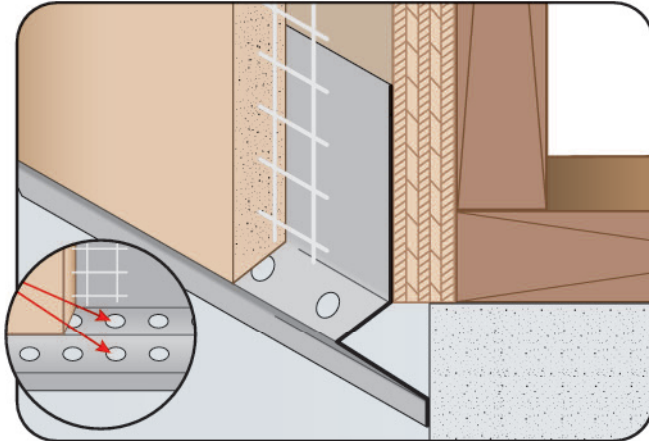

OWS: Offset Weep Screenshot

- Superior™ Moisture Protection
- Available With 1/2" Weep Holes or No Weep Holes
- Available Curved Upon Request
- Available in Aluminum, Copper, Galvanized Steel, Bonderized, Galvalume®, Stainless Steel or Zinc

A special weep screed for those conditions where the sheer wall exceeds the foundation in plane. This special design permits the bottom leg of the weep screed to return back to the foundation

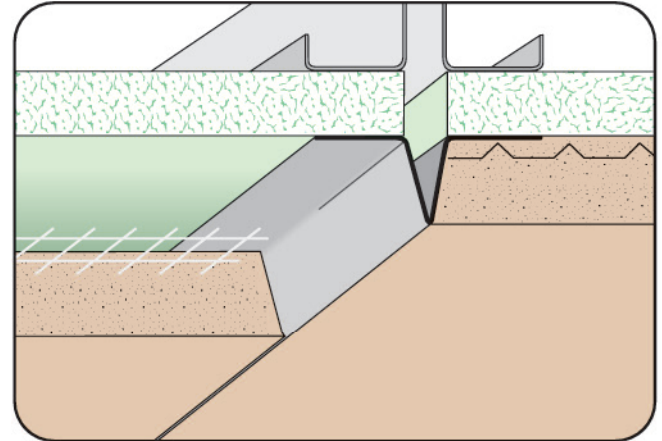

PBS: Pointed Base Screenshot

- Available With 1/2" Key Holes or No Holes
- Available in Aluminum, Copper, Galvanized Steel, Bonderized, Galvalume®, Stainless Steel or Zinc

The pointed base screed functions as a control joint and depth screed in the plaster. The base screed comes with or without 1/2" key holes in the flange for a mechanical key.

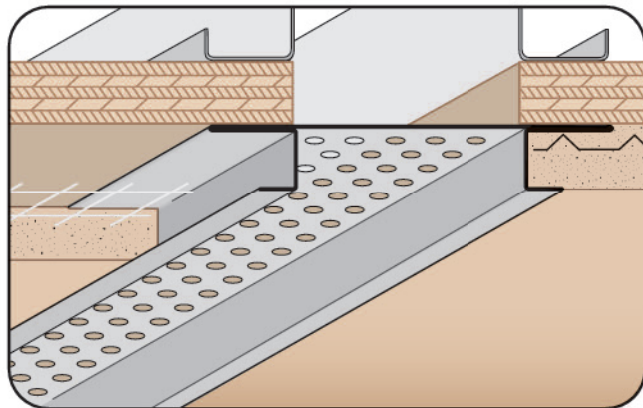

PCS: Plaster Channel Screenshot

- Available With 1/8", 1/4" Vent Holes or No Vent
- Available Curved Upon Request
- Available in Aluminum, Copper, Galvanized Steel, Bonderized, Galvalume®, Stainless Steel or Zinc

Channel screed style reveal that provides decorative shadow lines and accent stripes in an exterior finish. Has return keys for screeding of stucco. Can also be ordered vented for a perimeter air flow application.

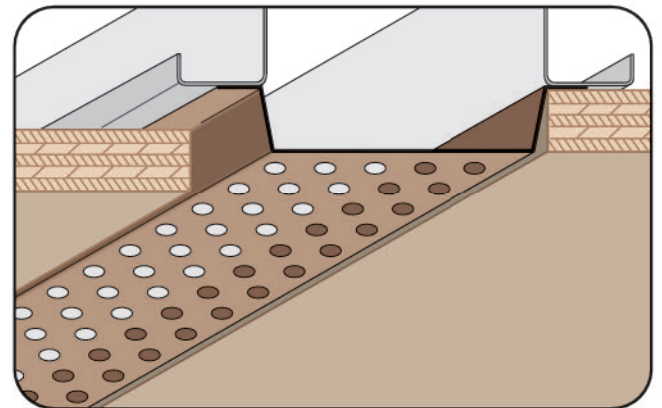

PSV: Plywood Style Vent

- Available With 1/8", 1/4" Vent Holes or No Holes
- Available Pre-Painted Brown, White or Unpainted
- Galvanized Steel Only

Specialty soffit vent for use with plywood soffit conditions.



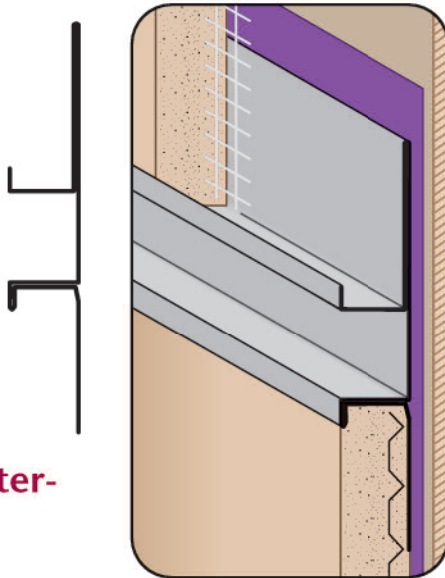

**PWC:
Plaster Water-
Resistant
Channel**

- SolidGround® Design For Moisture Protection
 - Available With 1/8" Weep Holes or No Holes
 - Available in Aluminum, Copper, Galvanized Steel, Bonderized, Galvalume®, Stainless Steel or Zinc
- One-piece SolidGround® design feature mitigates the concern of moisture penetration in a horizontal condition.

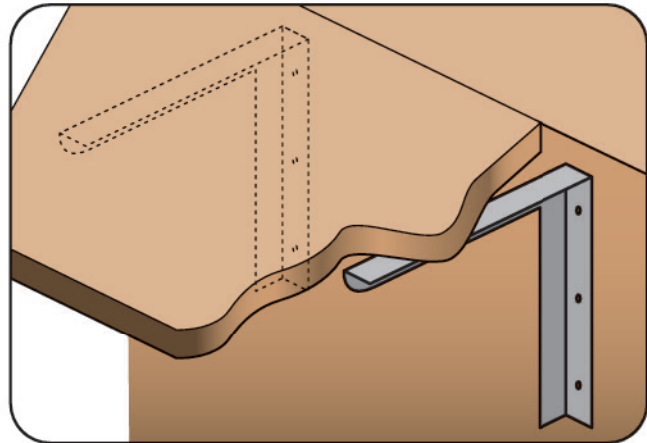

S-B: Counter Support Bracket

- Features A Radiuses Top Bar For Your Protection
- Available in 1/8", 3/16" or 1/4" Hot Rolled Steel (HR)

Our Counter Support Bracket are 90° support brackets are made from a single piece of material, then notched, bent and welded. The reinforced side wall offers greater support for your project.

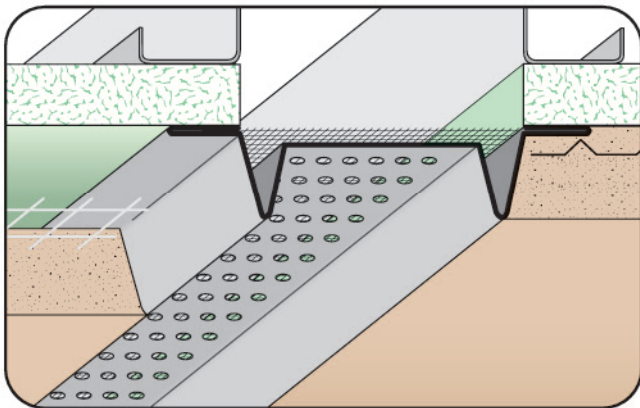
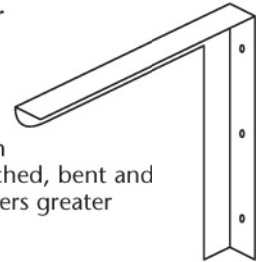

SBS: BugStop® Soffit Vent

- Available with 1/8" and 1/4" Vent Holes
- Galvanized Steel Only
- US Patent 85,120,158

"Allows air in; keeps bugs out." All the same features and value of our standard SVR screed, but with the addition of 0.062, 16-16 (1/16") aluminum screen that protects against the entry of wasps, bees, termites and other pests.

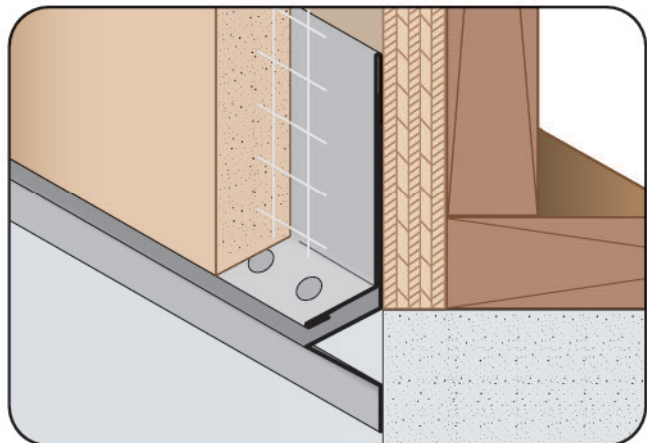

**SBW: Santa Barbara
Weep Screed™**

- Available With or Without 1/4" Weep Holes
- Available in Aluminum, Copper, Galvanized Steel, Bonderized, Galvalume®, Stainless Steel or Zinc

A unique one piece weep screed design that combines the features of a traditional foundation weep screed while providing an aesthetically pleasing look. The upper leg has a plaster stop with a 1/4" closed hem for safety and weep holes.





CUSTOM SIZES AVAILABLE!

Stockton Custom Fabrication
877-786-2587
custom@StocktonProducts.com

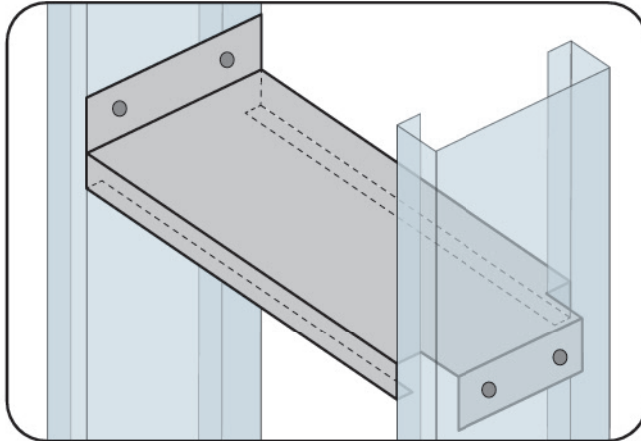

SBX: Stud Blocking

- Available in 3 5/8", 4", 6" And 8" Standard Widths
- Available in Galvanized Steel

The Stub Blocking provides horizontal bracing for studs and joists. Designed for 12", 16", and 24" stud layouts with a precut flange to fit between the studs for easy installation. Provides full bearing between the wall stud webs along the shear wall and prevention load transfer issues.

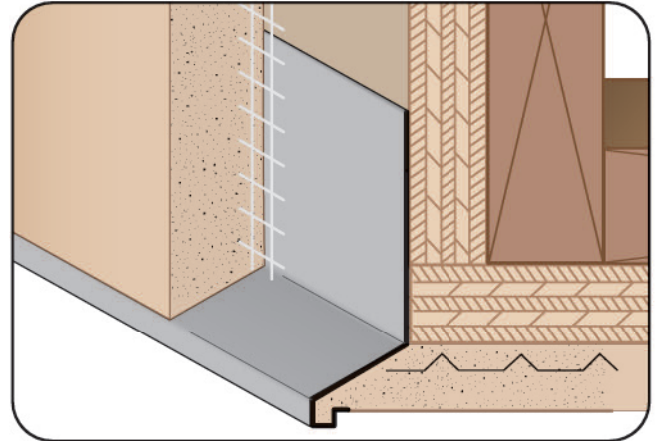
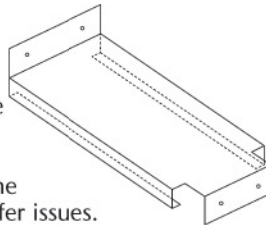

SDE: #12 Soffit Drip Edge™

- Superior™ Moisture Protection
- No Weep Holes
- Available Curved Upon Request
- Available in Aluminum, Copper, Galvanized Steel, Bonderized, Galvalume®, Stainless Steel or Zinc

The #12 drip molding is designed to be used as a drip molding at the fascia/soffit transition as well as at recessed window conditions to provide a decorative drip edge and plaster stop.

Note: #12 Soffit Drip Edge™ is a trademark of CEMCO.

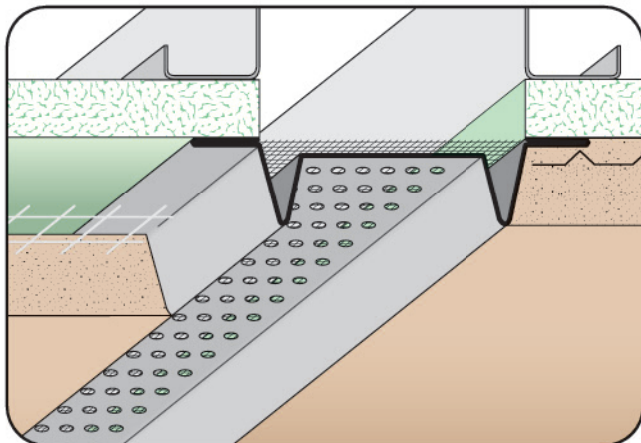

SES: EmberStop® Soffit Vent

- Available in Galvanized Steel Only
- US Patent 77,957,955

Allows air in while also designed for protection against ember entry. All the same features and value of our standard SVR screed, but with the addition of a 0.062, 16-16 (1/16") aluminum screen. Includes 1/8" vent holes.

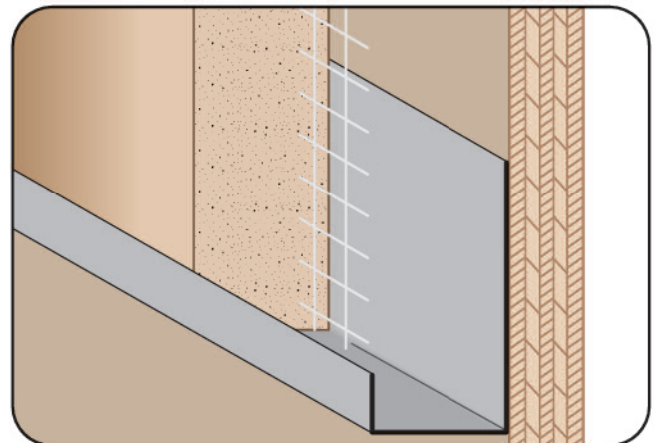

SFC: Short Flange Casing

- Available With 1/8" Weep Holes or No Holes
- Available Curved Upon Request
- Available in Aluminum, Copper, Galvanized Steel, Bonderized, Galvalume®, Stainless Steel or Zinc

This is the most frequently used casing bead for terminating drywall and plaster.

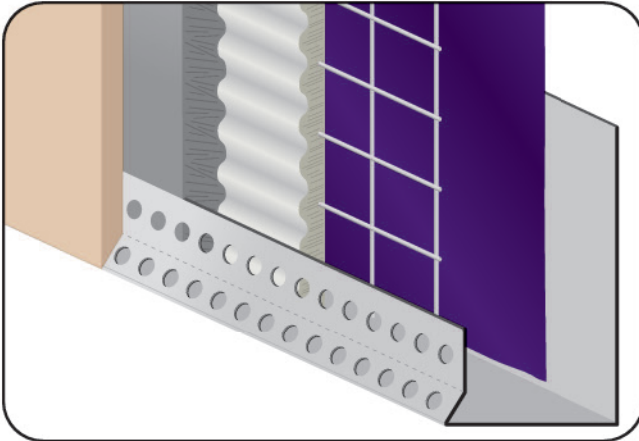

SFC88: Short Flange Casing Bead 88

- Available in Galvanized Steel, Galvalume® or Aluminum
- Patent Pending

The latest addition to our new "Finish Rite™" line of plaster trims, the SFC88 Short Flange casing bead solves the problem of controlling the brown coat thickness in a 3 and 4 coat system to exactly the 3/4" depth required by providing a special screed leg at this depth. 1/8" key holes provide good keying of the brown coat to the trim piece to help prevent separation cracking and delamination. The SFC88 Short Flange saves time, material costs and increases production rates not to mention a crack-free finish. No more excessive plaster build up! Control your finish, control your cost! Special sizes available. Please contact us for more information.

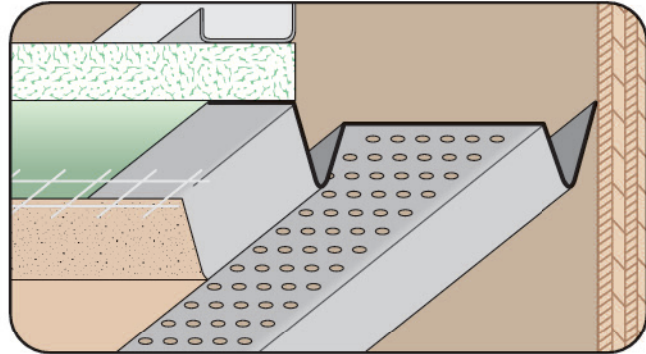

SFS: Single Flange Screed

- Available With 1/8", 1/4" Vent Holes or No Vent
 - Available Curved Upon Request
 - Available in Aluminum, Copper, Galvanized Steel, Bonderized, Galvalume®, Stainless Steel or Zinc
- Same as our standard vent, less one flange, designed to butt against walls on one side while providing a plaster stop on the other. Can be used in ceiling/wall or base conditions providing perimeter airflow. Available non-vented for use as a decorative reveal upon request.

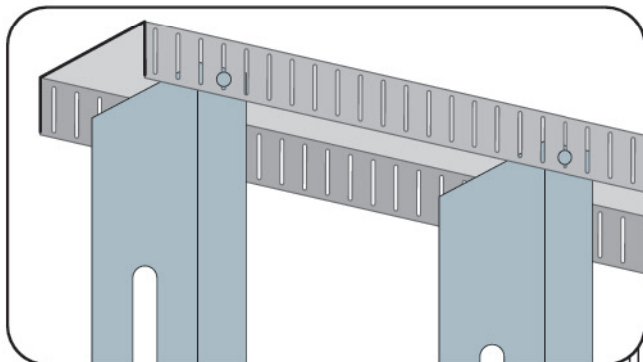

SLT: Slotted Slip Track

- Available in Galvanized Steel
- Our Slip Slotted Track is a deflection track with slots in the legs to allow for vertical deflection. Giving you head of wall vertical deflection.

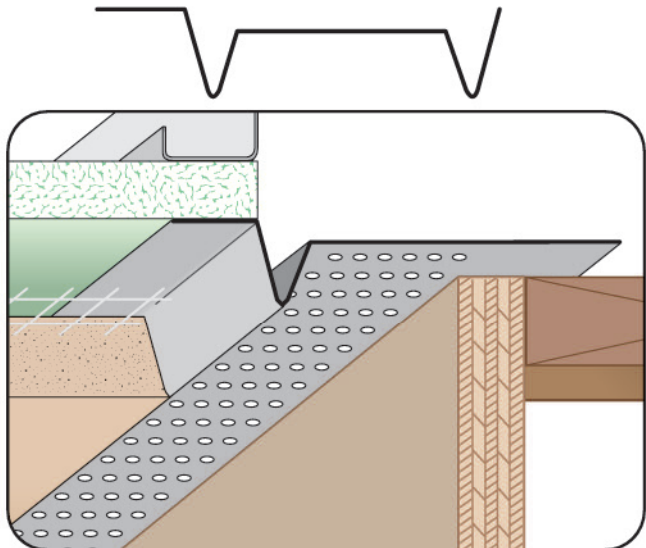

SPS: Single Point Screed

- Available With 1/8", 1/4" Vent Holes or No Vent
 - Available Curved Upon Request
 - Available in Aluminum, Copper, Galvanized Steel, Bonderized, Galvalume®, Stainless Steel or Zinc
- Single pointed vent used a at soffit/wall condition where uneven surfaces (such as split-faced block) exist providing perimeter airflow into the soffit. Available non-vented for use as a decorative reveal upon request.



CUSTOM SIZES AVAILABLE!

Stockton Custom Fabrication
877-786-2587
custom@StocktonProducts.com

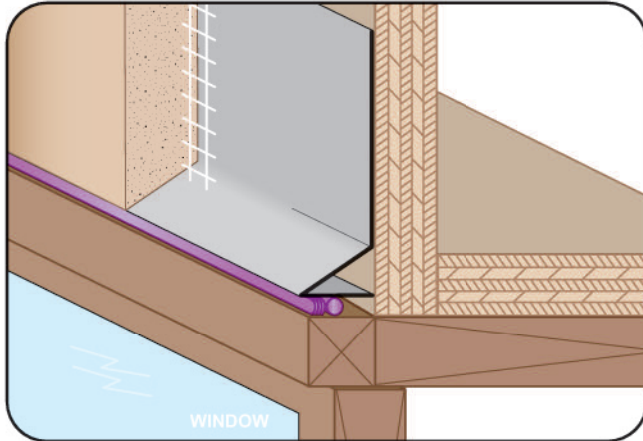

SRWS: #6 Solid Return Weep Screenshot

- Superior™ Moisture Protection
 - Available Curved Upon Request
 - Available in Aluminum, Copper, Galvanized Steel, Bonderized, Galvalume®, Stainless Steel or Zinc
- The #6 Solid Return Weep Screenshot in an angles drip screenshot that can be used at base of walls. It may also be used as a window or door head plaster stop and flashing piece.

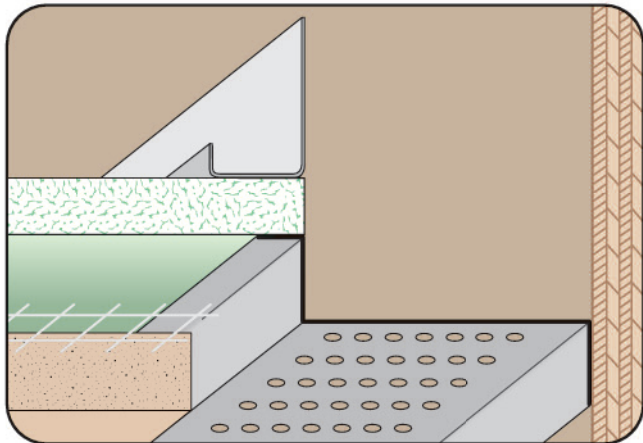

SSM: Step Separation Mold

- Available With 1/8", 1/4" Vent Holes or No Holes
 - Available in Aluminum, Copper, Galvanized Steel, Bonderized, Galvalume®, Stainless Steel or Zinc
- A versatile molding used primarily to separate either plaster or drywall from other materials.

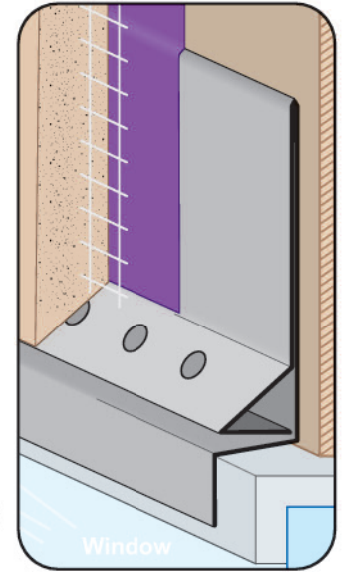

SSF: #3 Stucco Screenshot Flashing

- Superior™ Moisture Protection
 - Available With 1/4" Weep Holes or No Holes
 - Available Curved Upon Request
 - Available in Aluminum, Copper, Galvanized Steel, Bonderized, Galvalume®, Stainless Steel or Zinc
- SSF combines a stucco screenshot and head flashing into one uniformed piece. Weep screenshot allows moisture to escape and travel over top of flashing. SSF provides ideal water management at window head, floor line and transition to dissimilar materials. Available with and without weep holes.

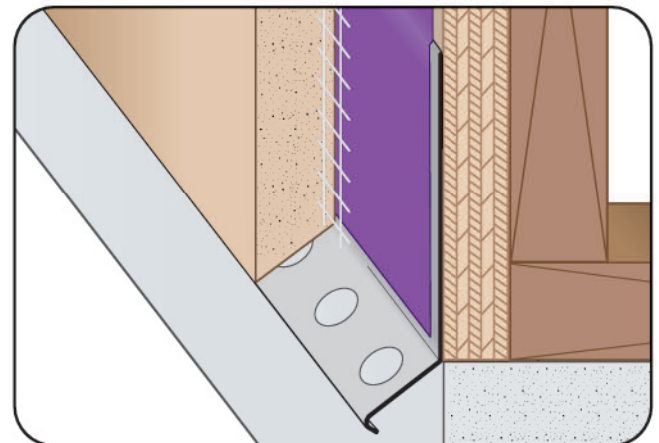

SST: #36 Weep Screenshot

- Superior™ Moisture Protection
 - Available With 1/2" Weep Holes or No Weep Holes
 - Available Curved Upon Request
 - Available in Aluminum, Copper, Galvanized Steel, Bonderized, Galvalume®, Stainless Steel or Zinc
- A variation of the traditional weep screenshot that provides a plaster stop and weep function at the foundation line.

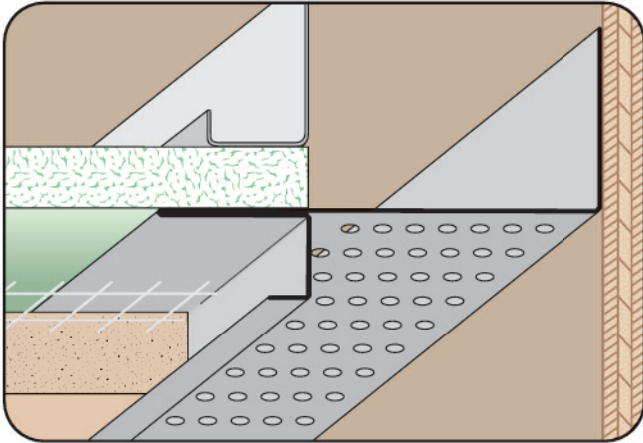

STM: Soffit Transition Mold

- Available With 1/8", 1/4" Vent Holes or No Vent
 - Available Curved Upon Request
 - Available in Aluminum, Copper, Galvanized Steel, Bonderized, Galvalume®, Stainless Steel or Zinc
- Provides a decorative transition between ceiling/wall with return keys for screeding of plaster. Can be vented for perimeter airflow into space above.

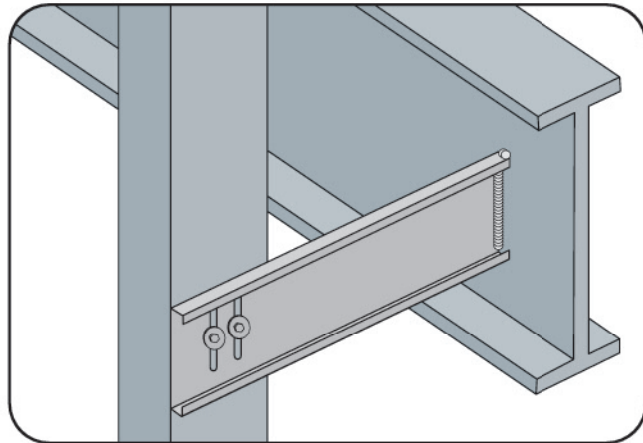

STS: Slotted Stud Sticker

- Available in Galvanized Steel
- The Slotted Stud Sticker is an extended single shear connector. It is used for horizontal surface applications and offers a higher capability of any horizontal surface connection clip. Can be connect to a beam by clip or welded directly to it. Slotted connectors to allow for vertical deflection.
- Note:** 3/8" returns on 16 ga or thinner, 3/4" returns on 12g a or thicker.

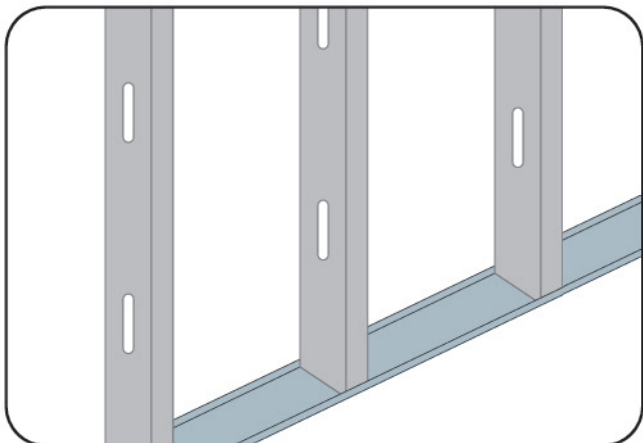

STU: Custom Stud

- Available in Punched or Unpunched
 - Available in Galvanized Steel
- Stockton Products' Custom Stud, produced to ASTM C955 standards, for load-bearing and curtain-wall framing. We offer our custom studs punched to allow conduit installation and wall bridging, or unpunched if preferred. Custom sizes and hole placement is available upon request.
- Note:** 3/8" returns on 14 ga or thinner, 3/4" returns on 12 ga or thicker.

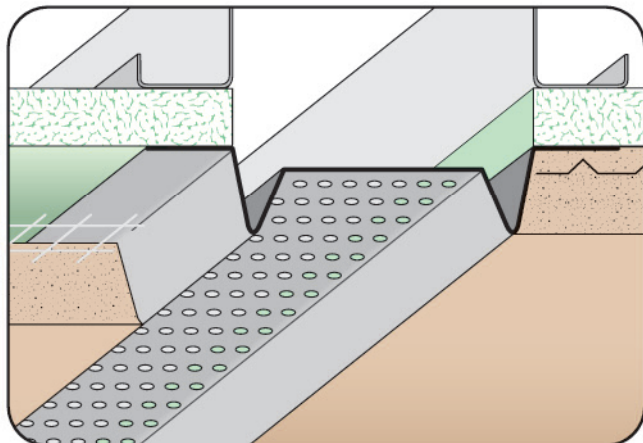

SVR: Soffit Vent/Reveal Screed

- Available With 1/8", 1/4" Vent Holes or No Vent
 - Available Curved Upon Request
 - Available in Aluminum, Copper, Galvanized Steel, Bonderized, Galvalume®, Stainless Steel or Zinc
- Standard soffit vent provides required perimeter airflow into soffit air space. Also available "non vented" for creating shadow lines/accent stripes in the stucco exterior, while providing crack control.



CUSTOM SIZES AVAILABLE!

Stockton Custom Fabrication
877-786-2587
custom@StocktonProducts.com

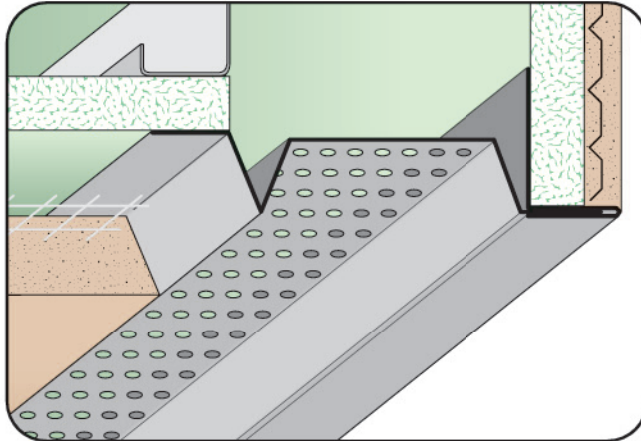

TPC: Two Piece Expansion Corner (2 Piece)

- Available With 1/8", 1/4" Vent Holes or No Holes
- Available in Aluminum, Copper, Galvanized Steel, Bonderized, Galvalume®, Stainless Steel or Zinc

A functional two piece product specifically designed for the fascia/soffit corner that provides a reveal and allows movement at this condition.

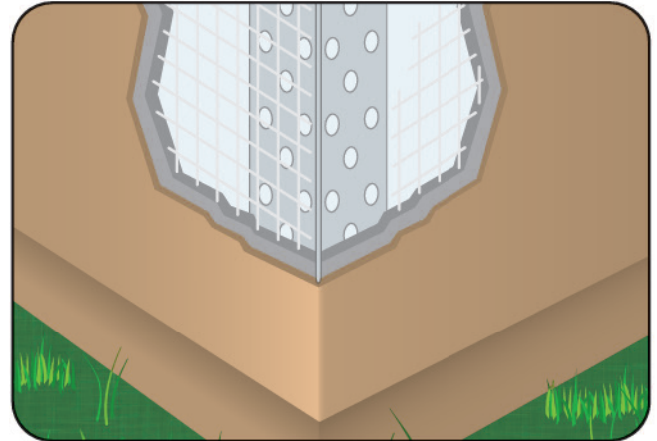
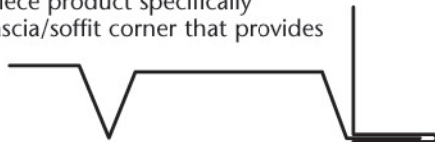

TRC: Tru-Corner®

- Available in Stainless Steel or Zinc
- A solid metal trim that provides a sharp square exterior corner. Longer attachment legs help assure proper alignment to achieve a straight and true corner, particularly on irregular framing. Includes 1/4" diameter staggered key holes to aid in keying the stucco. Available in stainless steel and zinc for maximum anti-corrosive protection.
- Note:** Ground depth (X Sizes) and leg lengths (Y Sizes) can not be mixed. Sizes are as listed.

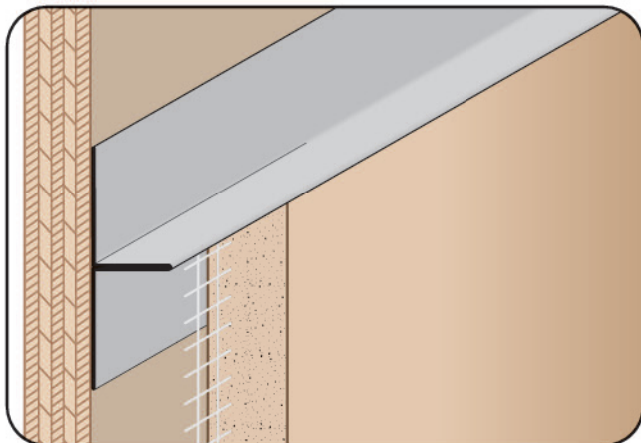

TRM: T Reveal Mold

- SolidGround® Design For Moisture Protection
- Available in Aluminum, Copper, Galvanized Steel, Bonderized, Galvalume®, Stainless Steel or Zinc

One-piece SolidGround® design feature mitigates the concern of moisture penetration in a horizontal condition. Provides a reveal and plaster stop at parapet top and function as a depth screed. Can be used at ceiling to wall conditions when dealing with dissimilar materials.

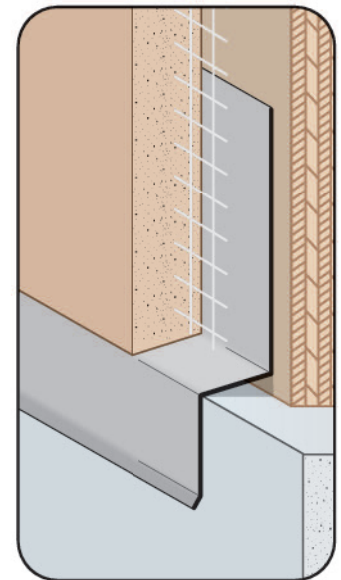

TSF: Transition Step Flashing

- Available Curved Upon Request
 - Available in Aluminum, Copper, Galvanized Steel, Bonderized, Galvalume®, Stainless Steel or Zinc
- A step flashing that provides a drip edge for top of windows and door conditions or where special flashing conditions are present.

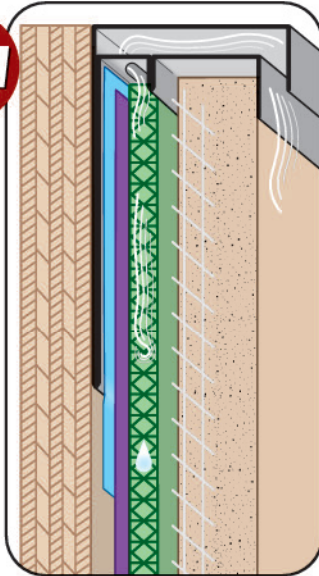

TVSS: Top Vent Stucco Screed

- Available in Aluminum, Copper, Galvanized Steel, Bonderized, Stainless Steel or Zinc
- Patent Pending

The Top Vent Stucco Screed is a single piece vented plaster stop specifically designed to be used with drainage mat to efficiently allow water vapor to escape through the concealed air slots.

The Top Vent Stucco Screed is fully customizable to be used with any ground size (stucco depth) or drainage mat thickness per IBC 2510.6.1

The Top Vent Stucco Screed is an ideal companion piece to use with Stockton's Tru-Weep™ line of stucco accessories.

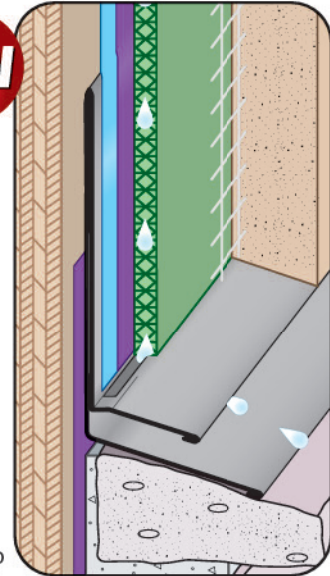

TWBF: Tru-Weep™ Base Flashing

- Included 3/16 x 2" Weep Slots
- Available in Aluminum, Copper, Galvanized Steel, Bonderized, Stainless Steel or Zinc

The Tru-Weep™ Weep Base Flashing is a single piece counter flashing stucco weep screed specifically designed to be used with drainage mat transition points between dissimilar claddings. Weep slots are located along the back of the sloped leg in alignment with the drainage mat to allow water to efficiently exit the stucco assembly.

Tru-Weep™ Base Flashing is in compliance with 2021 IBC: 2510.6.1

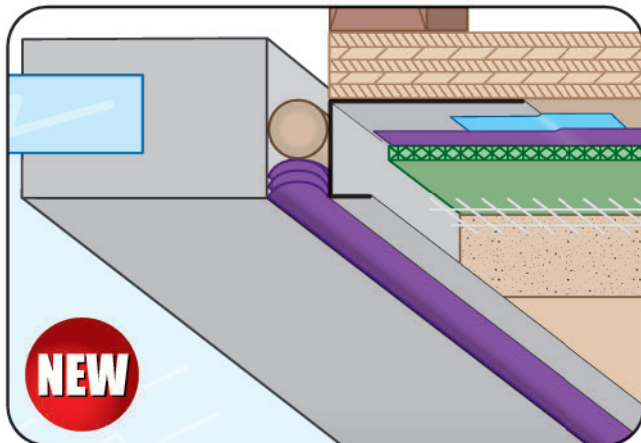

TWCB: Tru-Weep™ Casing Bead

- Available in Aluminum, Copper, Galvanized Steel, Bonderized, Stainless Steel or Zinc

The Tru-Weep™ Casing Bead is a non-perforated customizable stucco casing bead. Whether the stucco assembly is utilizing a drainage mat, continuous insulation, or traditional 3-coat the Tru-Weep™ Casing Bead can be ordered in any ground size to accommodate the stucco assembly.

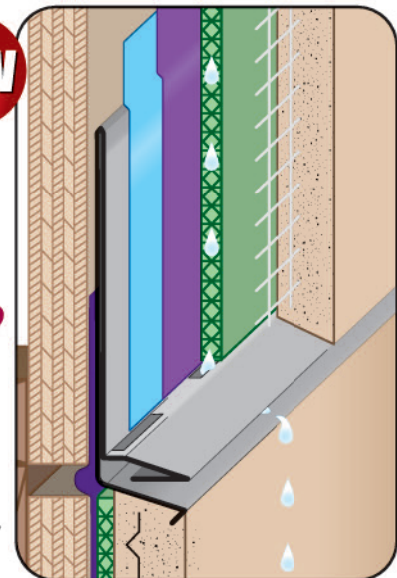

TWHJ: Tru-Weep™ #9 Horizontal Control Joint

- Included 3/16 x 2" Weep Slots
- Available in Aluminum, Copper, Galvanized Steel, Bonderized, Stainless Steel or Zinc

The Tru-Weep™ Horizontal Control Joint is a single piece horizontal control joint specifically designed to be used with drainage mat. Weep slots are located along the back of the sloped leg in alignment with the drainage mat to allow water to efficiently exit the stucco assembly.



CUSTOM SIZES AVAILABLE!

Stockton Custom Fabrication
877-786-2587
custom@StocktonProducts.com



PRODUCTS™

NEW

TWHJ-CI: Tru-Weep™ #9 Horizontal Control Joint

- Complies With IBC 2021 Drainage Mat Requirement For Stucco Systems
- Included 3/16 x 2" Weep Slots
- Available in Aluminum, Copper, Galvanized Steel, Bonderized, Stainless Steel or Zinc

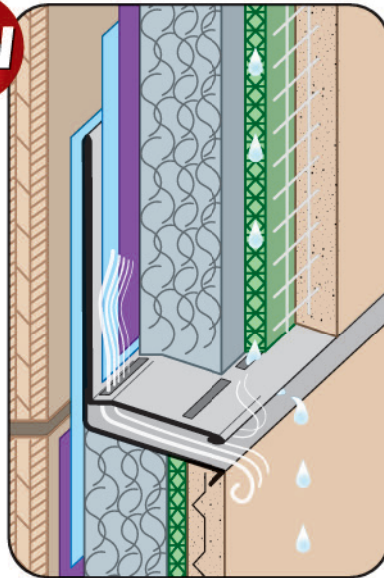

The Tru-Weep™ Stucco Accessories are a series of counter flashing stucco screeds specifically designed to be used with drainage mats and (CI) continuous insulation. Weep slots are located along the back of the sloped leg in alignment with the drainage mat to allow water to exit the stucco assembly efficiently.

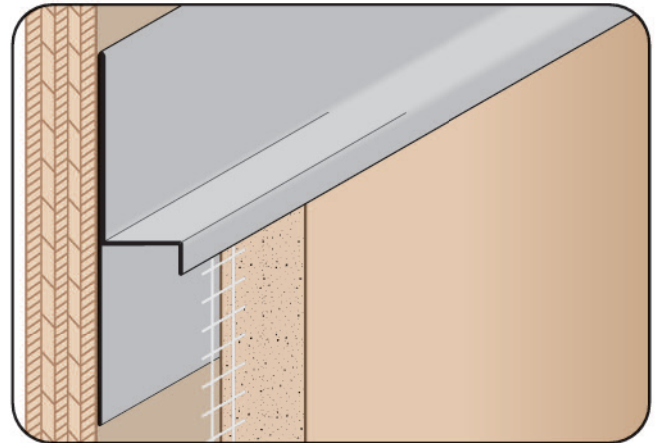

TWM: T Water-Resistant Molding

- SolidGround® Design For Moisture Protection
- Available in Aluminum, Copper, Galvanized Steel, Bonderized, Galvalume®, Stainless Steel or Zinc

One-piece SolidGround® design feature mitigates the concern of moisture penetration in a horizontal condition. Provides a plaster stop for top of wall/parapet conditions. SolidGround® design prevents moisture penetration at the top of the wall.

NEW

TWMFR: Tru-Weep™ Finish Rite® M-Slide Expansion Joint®

- Included 3/16 x 2" Weep Slots
- Available in Aluminum, Copper, Galvanized Steel, Bonderized, Stainless Steel or Zinc
- US Patent 7,673,421 B2

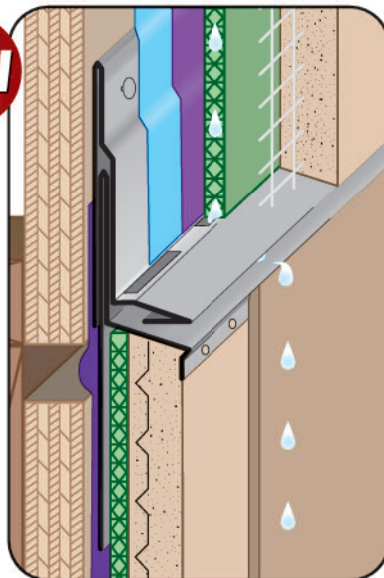

The Tru-Weep™ M-Slide Expansion Joint® accessory is specifically designed to be used with drainage mat. Weep slots are located along the back of the sloped leg in alignment with the drainage mat to allow water to efficiently exit the stucco assembly.

NEW

TWMSC: Tru-Weep™ M-Slide Expansion Joint®

- Included 3/16 x 2" Weep Slots
- Available in Aluminum, Copper, Galvanized Steel, Bonderized, Stainless Steel or Zinc
- US Patent 7,673,421 B2

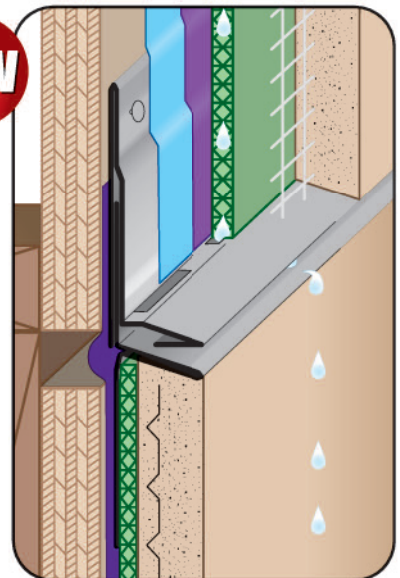

The Tru-Weep™ M-Slide Expansion Joint® accessory is specifically designed to be used with drainage mat. Weep slots are located along the back of the sloped leg in alignment with the drainage mat to allow water to efficiently exit the stucco assembly.



NEW

**TWMSX:
Tru-Weep™
M-Slide
Expansion
Joint®**

- Included 3/16 x 2" Weep Slots
- Available in Aluminum, Copper, Galvanized Steel, Bonderized, Stainless Steel or Zinc
- US Patent 7,673,421 B2

The Tru-Weep™ M-Slide Expansion Joint® accessory is specifically designed to be used with drainage mat. Weep slots are located along the back of the sloped leg in alignment with the drainage mat to allow water to efficiently exit the stucco assembly.

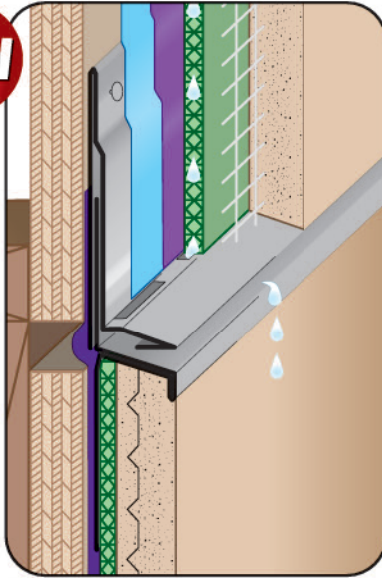

NEW

**TWMW:
Tru-Weep™
Midwall
Vent**

- Included 3/16 x 2" Weep Slots
- Available in Aluminum, Copper, Galvanized Steel, Bonderized, Stainless Steel or Zinc
- Patent Pending

The Tru-Weep™ Midwall Vent is a two piece horizontal control joint specifically designed to be used with drainage mat. This unique design allows for the top of the wall to drain moisture, and the bottom of the wall to vent air at the same midwall reveal. Weep slots are located along the back of the sloped legs in alignment with the drainage mats to allow water and air to efficiently exit the stucco assembly.

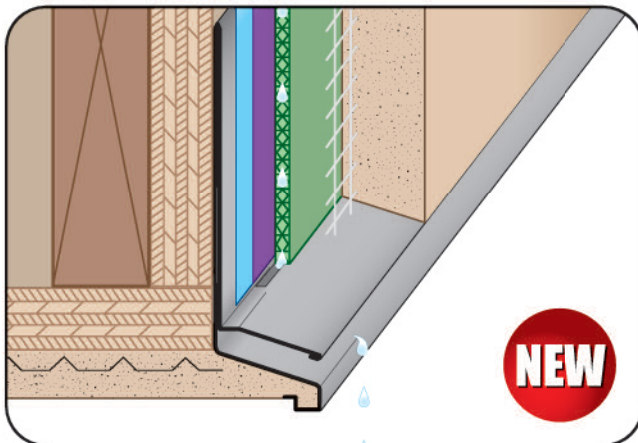
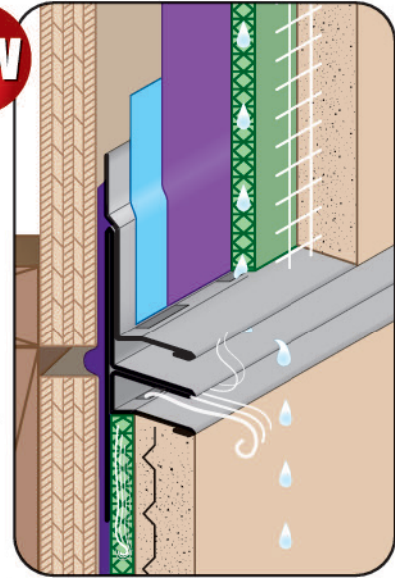

NEW

TWSD: Tru-Weep Soffit Drip

- Included 3/16 x 2" Weep Slots
- Available in Aluminum, Copper, Galvanized Steel, Bonderized, Stainless Steel or Zinc

The Tru-Weep™ Soffit Drip is a customizable soffit drip edge specifically designed to be used with drain mat stucco assemblies. Weep slots are located along the back of the sloped leg in alignment with the drainage mat to allow water to efficiently exit the stucco assembly.

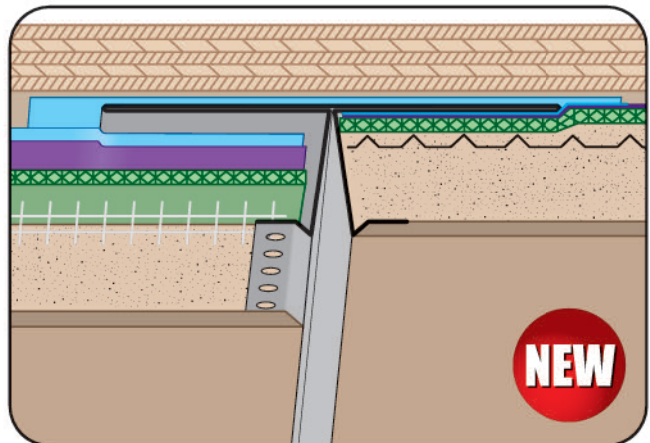

NEW

**TWVJ: Tru-Weep™
Vertical Control Joint**

- Available in Aluminum, Copper, Galvanized Steel, Bonderized, Stainless Steel or Zinc

The Tru-Weep™ Vertical Control Joint is a customizable vertical control joint specifically designed to be used with drainage mat stucco assemblies. Tru-Weep™ Vertical Control Joint is to be used with drainage mat stucco assemblies per 2021 IBC: 2510.6.1



CUSTOM SIZES AVAILABLE!

Stockton Custom Fabrication
877-786-2587
custom@StocktonProducts.com

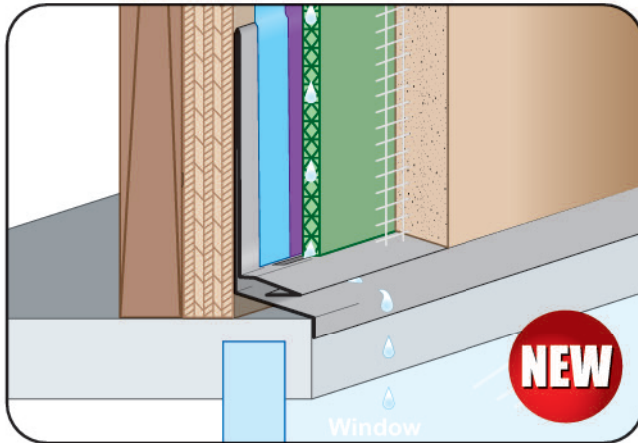

TWWF: Tru-Weep™ Window Head Flashing

- Included 3/16 x 2" Weep Slots
- Available in Aluminum, Copper, Galvanized Steel, Bonderized, Stainless Steel or Zinc

The Tru-Weep™ Window Flashing is a single piece window head flashing weep specifically designed to be used with drainage mat. Weep slots are located along the back of the sloped leg in alignment with the drainage mat to allow water to efficiently exit the stucco assembly.

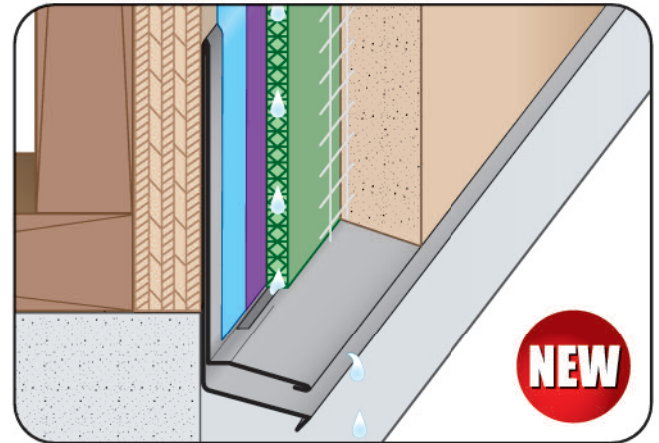

TWWT: Tru-Weep™ Weep Screed

- Included 3/16 x 2" Weep Slots
- Available in Aluminum, Copper, Galvanized Steel, Bonderized, Stainless Steel or Zinc

The Tru-Weep™ Weep Screed is a single piece counter flashing stucco weep screed specifically designed to be used with drainage mat. Weep slots are located along the back of the sloped leg in alignment with the drainage mat to allow water to efficiently exit the stucco assembly.

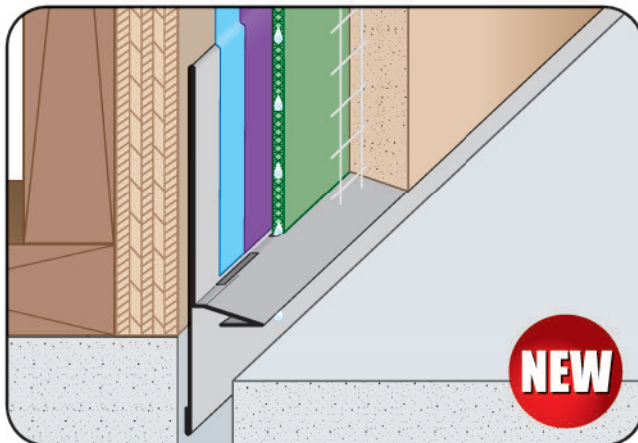

TWXLF: Tru-Weep™ XL Foundation Screed

- Available in Aluminum, Copper, Galvanized Steel, Bonderized, Stainless Steel or Zinc

Stucco installation guidelines require stucco to be held up off the hardscape 2". The TWXLF provides weep slots in line with the drainage mat to maximize the drainage and ventilation per 2021 IBC: 2510.6.1

The extended back flashing leg will protect balcony waterproofing membranes.

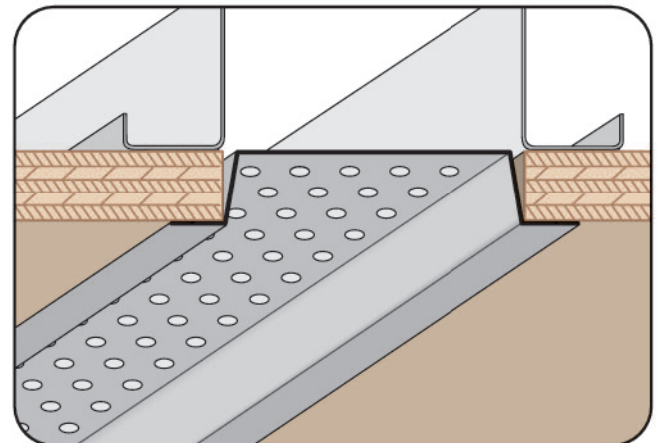

VHC: Vented Hat Screed

- Available With 1/8", 1/4" Vent Holes or No Vent
- Available Curved Upon Request
- Available in Aluminum, Copper, Galvanized Steel, Bonderized, Galvalume®, Stainless Steel or Zinc

This screed offers ventilation while providing a finished, "flush" reveal for use in a soffit condition.



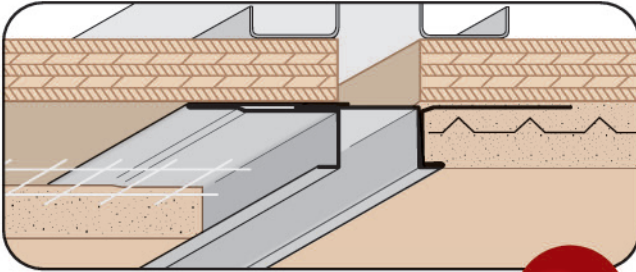

VMS: Vertical M-Slide Expansion Joint® (2 Piece)



- Superior™ Moisture Protection
- SolidGround® Design For Moisture Protection
- Available With 1/8" Weep Holes or No Holes
- Available in Aluminum, Copper, Galvanized Steel, Bonderized, Galvalume®, Stainless Steel or Zinc
- US Patent 7,673,421 B2

The unique hem design stops moisture penetration in a horizontal condition. The two-piece design allows for movement. Special "Step" on the attachment leg provides a locator for correct placement of the fasteners and helps keep the molding laying flat on the wall. Matching manufacturing plant miter-cut, solid-soldered inside and outside corners are available, giving you moisture management confidence throughout the entire installation.

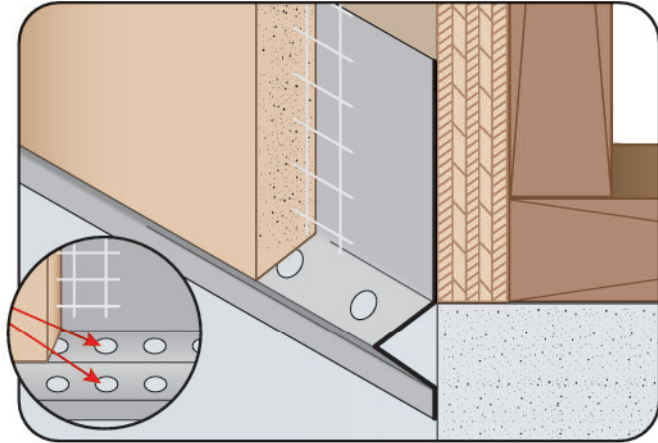

W-S: #7 Weep Screed

- Superior™ Moisture Protection
- Available With 1/2" Weep Holes or No Holes
- Available Curved Upon Request
- Available in Aluminum, Copper, Galvanized Steel, Bonderized, Galvalume®, Stainless Steel or Zinc

A traditional weep screed that provides a plaster stop and functions as a weep screed at the foundation. Available with and without weep holes.

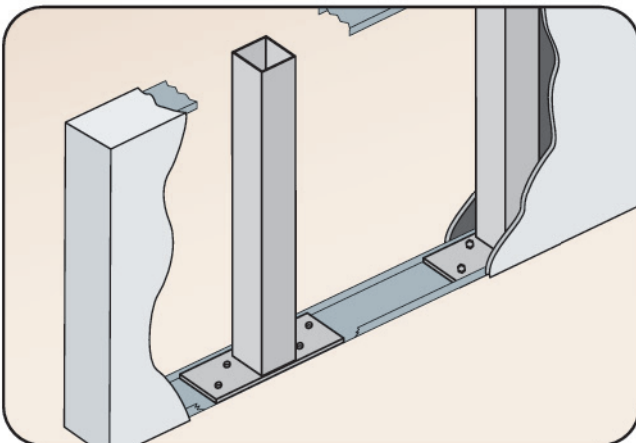

WPX-R: Wall Post (Rectangular Base)

- 2 1/4" x 6" Rectangle Base (3/16" HR Base Plate)
- Includes Four 7/16" Dia. Holes
- Available in 36", 48" and 60" Height
- 3/16" Hot Roll (HR) Steel Standard

Wall post are used in pony walls (half walls). The wall post is mounted to a guide track or directly to the floor structure. Which add strength and rigidity to the short wall by acting as an anchor to the floor. Generally a 2 1/4" x 6" rectangle base wall post would be used in 2 1/2" pony walls.

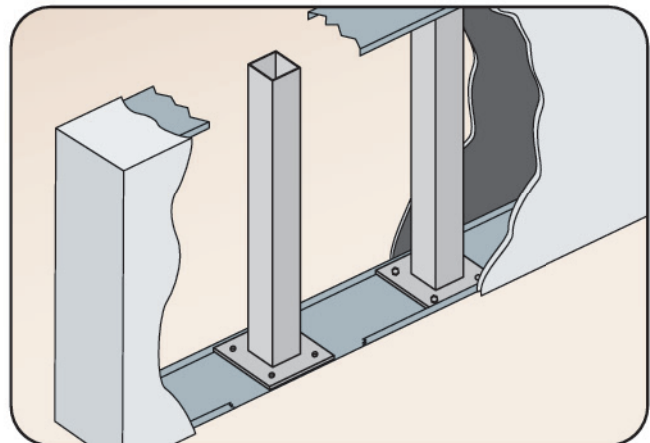
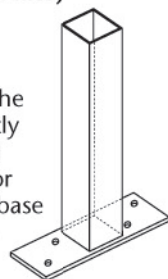

WPX-S: Wall Post (Square Base)

- 3 1/2" Square Base (3/16" HR Base Plate)
- Includes Four 7/16" Dia. Holes
- Available in 36", 48" And 60" Height
- 3/16" Hot Roll Steel Standard

Wall post are used in pony walls (half walls). The wall post is mounted to a guide track or directly to the floor structure. Which add strength and rigidity to the short 3 1/2" square base wall post would be used in 3 5/8" pony walls.

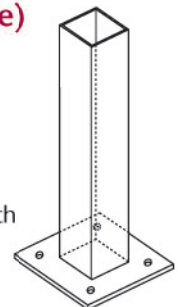



CUSTOM SIZES AVAILABLE!

Stockton Custom Fabrication
877-786-2587
custom@StocktonProducts.com

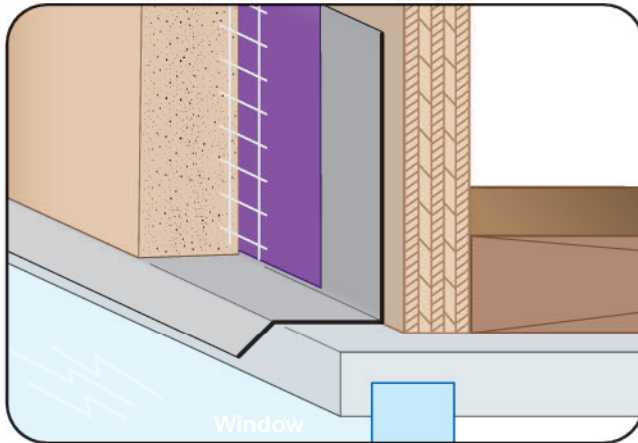

WTP: Window Termination Point

- Available Curved Upon Request
 - Available in Aluminum, Copper, Galvanized Steel, Bonderized, Galvalume®, Stainless Steel or Zinc
- Provides a termination/drip edge above exterior door and window heads.

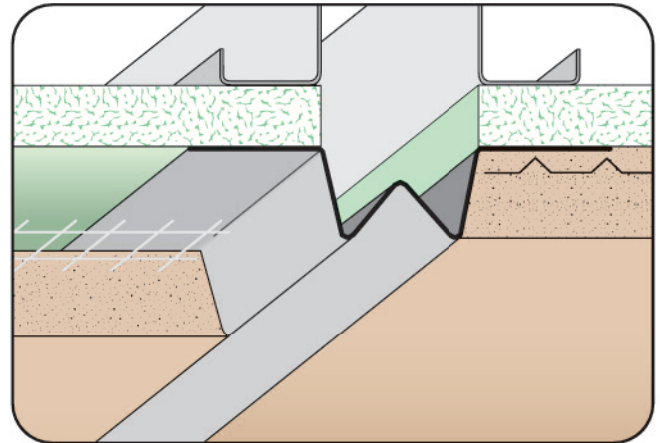

WVS: Wide V Screed

- Available Curved Upon Request
 - Available in Aluminum, Copper, Galvanized Steel, Bonderized, Galvalume®, Stainless Steel or Zinc
- A decorative plaster control joint for conditions that require a small or minimal reveal.

WXJ: Water Management Expansion Joint (2 Piece)

- Superior Moisture Protection™
- Available With 1/4" Weep Holes or No Weep Holes
- Available in Aluminum, Copper, Galvanized Steel, Bonderized, Galvalume®, Stainless Steel or Zinc
- US Patent D850656

Similar to the M-Slide Expansion Joint® design, the WXJ is a two piece expansion joint that provides Superior Moisture Protection™ while offering movement at floor lines and other conditions requiring an expansion joint. Unique design provides a uniform look to the plaster return keys on both top and bottom legs when finished.

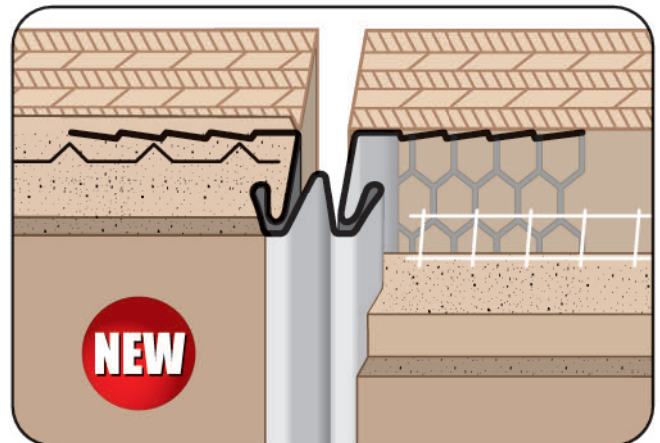
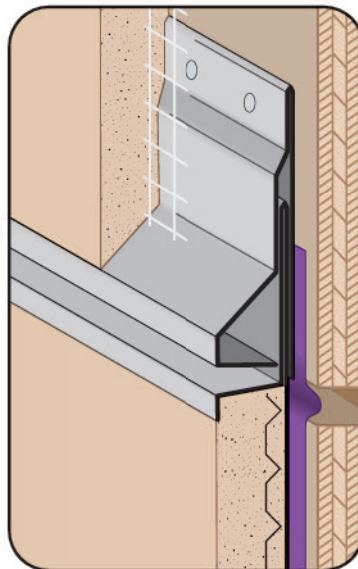

XDJ: Double J Control Joint

- Features Expanded Metal Flanges
 - Includes Taped Reveal
 - Available in Galvanized Steel (GS) 26 ga. G60
- Double J Control Joint expanded flange are used to relieve stresses of expansion and contraction of minor thermal movement in plaster walls and ceilings. The Double J has a taped, 5/16" reveal and rolled outer edges to minimize visible separation cracking. This product has expanded flanges on both sides for proper keying of the scratch and brown coat.

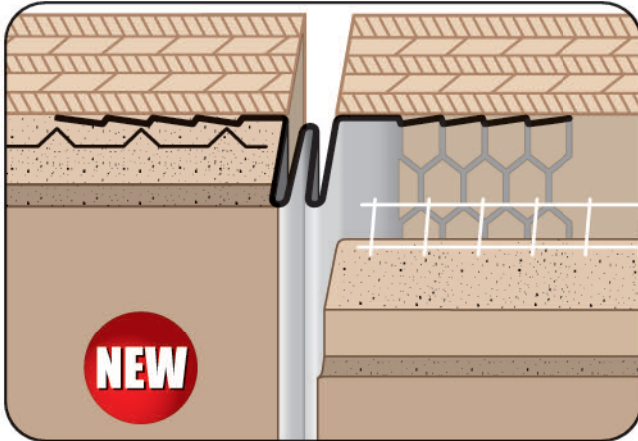

XDV: #15 Double V Control Joint

- Features Expanded Metal Flanges
 - Available in Galvanized Steel (GS) 26 ga. G60
- #15 Double V Control joints are used to relieve stresses of expansion and contraction of minor thermal movement in plaster walls and ceilings. This inconspicuous profile provides stress relief and finishing point for the top color coat. This product has expanded flanges on both sides for proper keying of the scratch and brown coat.

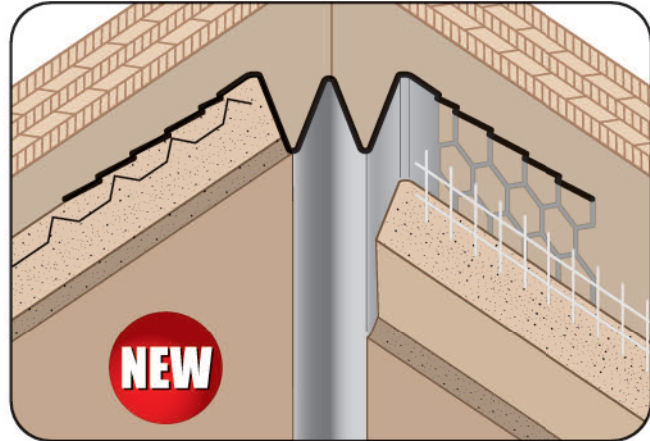

XEC: #30 Expansion Control Joint

- Features Expanded Metal Flanges
 - Available in Galvanized Steel (GS) 26 ga. G60
- #30 Expansion Control Joints are used to relieve stresses of expansion and contraction of minor thermal movement at the corners of plaster walls and ceilings. This inconspicuous profile provides stress relief and finishing point for the top color coat. This product has expanded flanges on both sides for proper keying of the scratch and brown coat.

XLF: #7 Extended Weep Scream

- Superior™ Moisture Protection
 - Available Curved Upon Request
 - Available in Aluminum, Copper, Galvanized Steel, Bonderized, Galvalume®, Stainless Steel or Zinc
- Stucco installation guidelines require stucco to be held up off of hardscape. Provides an extended back leg to protect waterproof membranes.

Note: Weep holes are available in some configurations. Please call customer service for details.

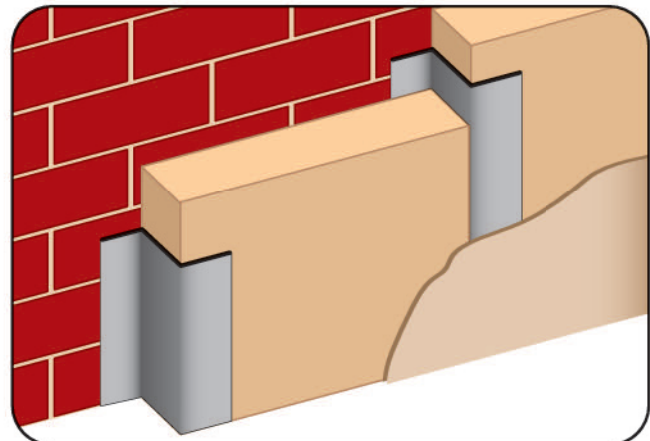
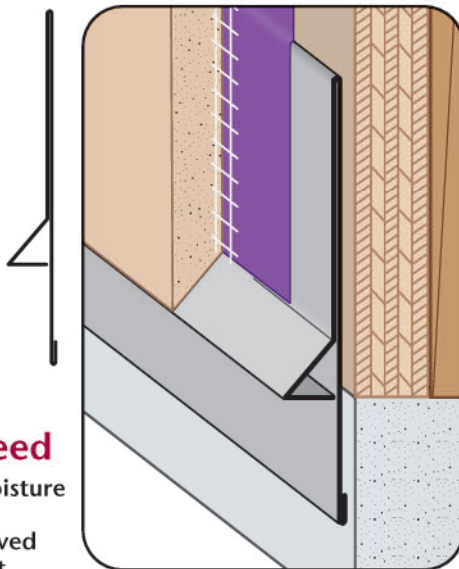

Z-B: Custom Z-Bar

- Available in Aluminum, Copper, Galvanized Steel, Bonderized, Galvalume®, Stainless Steel or Zinc
- Z-Bar provides a method of attaching rigid insulation and other material.

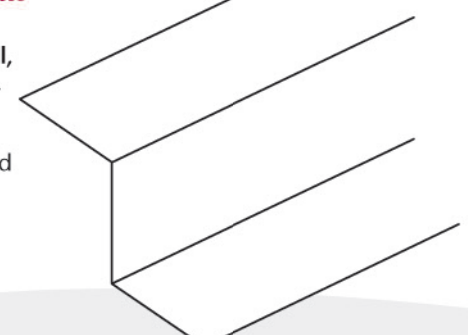



CUSTOM SIZES AVAILABLE!

Stockton Custom Fabrication
877-786-2587
custom@StocktonProducts.com

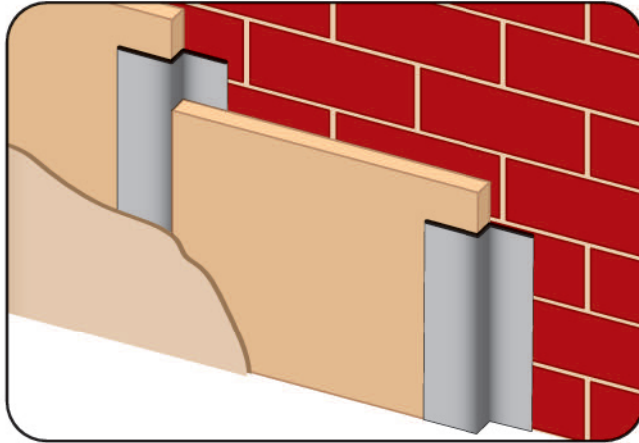

Z-B/LP: Custom Z-Bar Low Profile

- Available in Aluminum, Copper, Galvanized Steel, Bonderized, Galvalume®, Stainless Steel or Zinc

Stockton's Custom Z-Bar Low Profile features a 1/4" step. The small tight Z provides the opportunity to use thinner materials when the project calls for it. Provides rigid insulation and attachment of insulation, drywall or veneer to the interior of masonry walls. Z-Bars are generally used vertically to hold a cover materials against a wall to prevent dampness or resurface with a difference material.

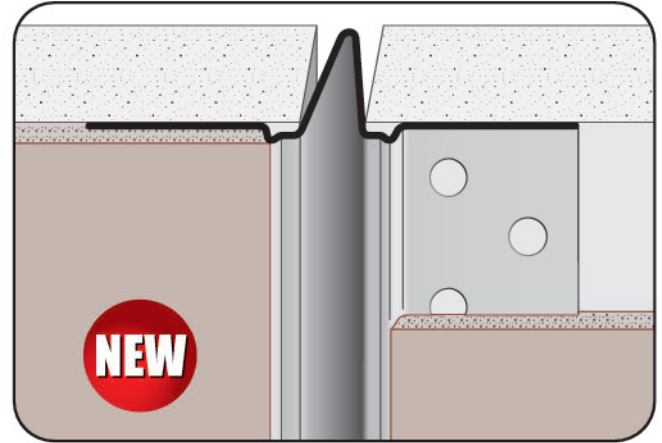

ZCJ: 093 Zinc Control Joint

- Available in Zinc

093 Zinc Control Joint is designed for both interior plaster applications, and drywall applications allowing for controlled expansion and contraction of the ceiling or wall finish. Manufactured from 26 ga. zinc, and formed to exacting tolerances, the release tape on the joint protect the profile to provide for a clean edge in both plaster and veneer finishes.

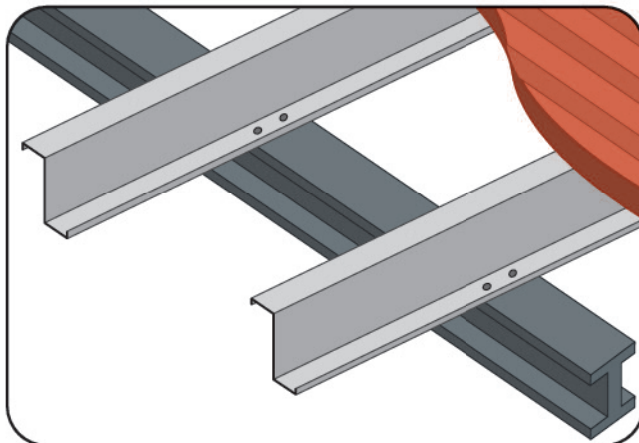

Z-P: Custom Z-Purlin

- Available in Galvanized Steel

Z-Purlin typically refers to roof framing members that span parallel to the building eave and support the roof decking or sheeting. The Z-Purlins are supported by the roofs cross beams or walls.

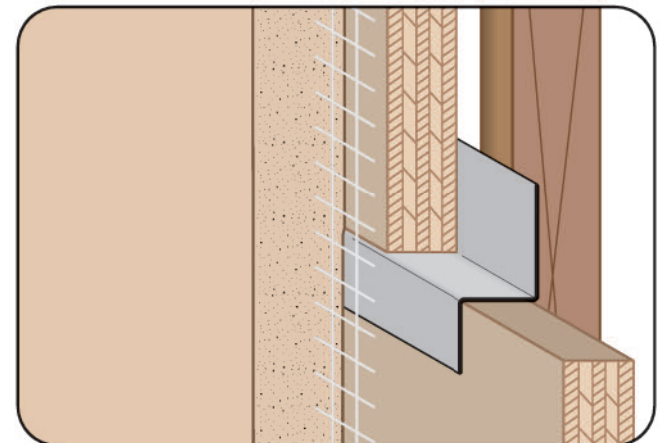
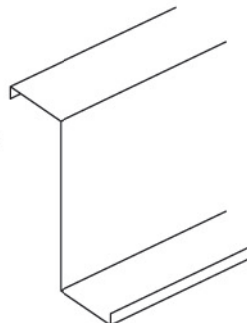

Z-T: Z Trim

- Available Curved Upon Request
- Available in Aluminum, Copper, Galvanized Steel, Bonderized, Galvalume®, Stainless Steel or Zinc

Used to properly seal and join two pieces of plywood and other conditions where a "Z" shape is required.



The logo for Stockton Products, featuring the word "Stockton" in a white, cursive script font on a red, triangular background that points to the right.

PRODUCTS™

WIRE CORNER PRODUCTS

Featuring: **CornerAid®**, **WeepAid®**,
ArchAid®, **StockAid®**, **PopOutAid™**
and **FormAid™**

Stockton Products™ offers the industry's most complete line of quality welded wire corner products. Available in galvanized or stainless steel as well as with a plastic nose for high humidity environments.

To see our selection of
Wire Products visit:
www.StocktonProducts.com/WIRE





Stockton

PRODUCTS™

EXTRUDED PRODUCTS

We manufacture a full line of standard and custom extruded aluminum products for stucco and drywall. We offer radius shapes, intersections, vented/unvented, weep holes and key holes. Choose from a variety of industrial finishes. Plus a large selection of fiber cement p Panel moldings.

To see our selection of
Wire Products visit:
www.StocktonProducts.com/EXTRUDED





PRODUCTS™

Stockton Products™ offers a wide variety of products for the construction market. Including the industry's most complete line of quality welded wire corner products, an extensive variety of standard and custom metal products for ventilation, moisture management and decorative reveal, and a full line of standard and custom extruded aluminum products for stucco and drywall.

Wire Products

CornerAid® And Other Welded Wire Products
For Stucco, Drywall & Fireproofing
**Galvanized • Stainless Steel
Plastic Nose • Specialty Products**

The originator of welded wire CornerAid®, Stockton continues to provide the lath & plaster professional with quality wire products for a variety of applications.



Metal Products

Roll And Brake Formed Metal Plaster Stops,
Expansion Joints And Control Joints
**Copper • Galvanized • Bonderized
Galvalume® • Zinc • Stainless Steel • Aluminum**

Decorative accessories for plaster, drywall, moisture protection, ventilation and other applications. Radius curves, corners and custom fabrication.

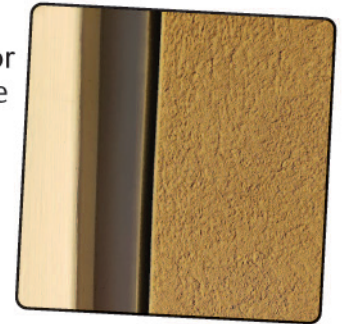

Extruded Products

Standard & Custom Reveal Moldings
For Stucco, Drywall & Fiber Cement Board
**Clear Anodized • Alodine/Chem-Film
Powder Coat • Kynar Paint • Color Anodized**

Complete line of extruded aluminum trims for stucco, drywall and fiber cement panels. Custom shapes, curving and special fabrication available.

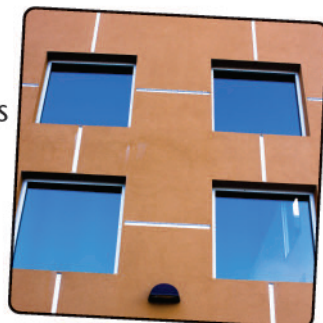

Custom Fabrication

Stockton Products™ has made some exciting changes. In order to expand our metal forming capabilities, we've made a significant investment in state-of-the-art equipment.

Our new capacity permits us to greatly expand our product line and market reach and give us the ability to offer all types of custom fabricated.



www.StocktonProducts.com

877-862-5866